

Service Manual

DV110/N1S

DVD / Tuner

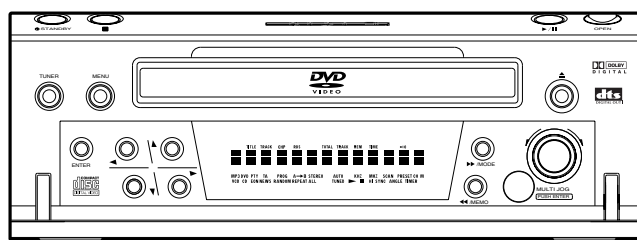
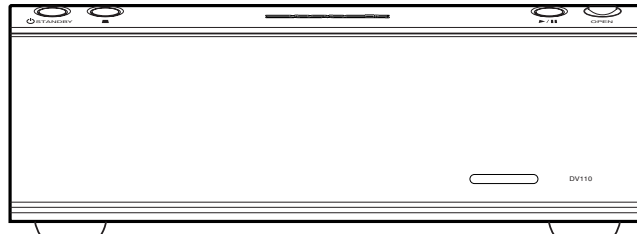

TABLE OF CONTENTS

| SECTION | PAGE |
|--|------|
| 1. TECHNICAL SPECIFICATIONS | 1 |
| 2. SERVICE INFORMATION AND PROCEDURE | 4 |
| 3. WIRING DIAGRAM | 9 |
| 4. BLOCK DIAGRAM | 11 |
| 5. SCHEMATIC DIAGRAM | 13 |
| 6. PARTS LOCATION | 15 |
| 7. IC DATA | 22 |
| 8. EXPLODED VIEW AND PARTS LIST | 25 |
| 9. ELECTRICAL PARTS LIST | 29 |

Please use this service manual with referring to the user guide (D.F.U.) without fail.

修理の際は、必ず取扱説明書を準備し操作方法を確認の上作業を行ってください。

marantz®

DV110

MARANTZ DESIGN AND SERVICE

Using superior design and selected high grade components, **MARANTZ** company has created the ultimate in stereo sound. Only original **MARANTZ** parts can insure that your **MARANTZ** product will continue to perform to the specifications for which it is famous.

Parts for your **MARANTZ** equipment are generally available to our National Marantz Subsidiary or Agent.

ORDERING PARTS :

Parts can be ordered either by mail or by Fax.. In both cases, the correct part number has to be specified.

The following information must be supplied to eliminate delays in processing your order :

1. Complete address
2. Complete part numbers and quantities required
3. Description of parts
4. Model number for which part is required
5. Way of shipment
6. Signature : any order form or Fax. must be signed, otherwise such part order will be considered as null and void.

USA

MARANTZ AMERICA, INC
1100 MAPLEWOOD DRIVE
ITASCA, IL. 60143
USA
PHONE : 630 - 741 - 0300
FAX : 630 - 741 - 0301

EUROPE / TRADING

MARANTZ EUROPE B.V.
P. O. BOX 8744, BUILDING SILVERPOINT
BEEMDSTRAAT 11, 5653 MA EINDHOVEN
THE NETHERLANDS
PHONE : +31 - 40 - 2507844
FAX : +31 - 40 - 2507860

CANADA

LENBROOK INDUSTRIES LIMITED
633 GRANITE COURT,
PICKERING, ONTARIO L1W 3K1
CANADA
PHONE : 905 - 831 - 6333
FAX : 905 - 831 - 6936

PROFESSIONAL AMERICAS

SUPERSCOPE TECHNOLOGIES, INC.
MARANTZ PROFESSIONAL PRODUCTS
2640 WHITE OAK CIRCLE, SUITE A
AURORA, ILLINOIS 60504 USA
PHONE : 630 - 820 - 4800
FAX : 630 - 820 - 8103

PROFESSIONAL AUSTRALIA

TECHNICAL AUDIO GROUP PTY, LTD
43-53 Bridge Rd.,
STANMORE NSW 2048
AUSTRALIA
PHONE : +61 - (0)2 - 9519 - 0900
FAX : +61 - (0)2 - 9519 - 0600

PROFESSIONAL HONG KONG

Jolly ProAudio Broadcast Engineering Ltd.
UNIT 2, 10F, WAH HUNG CENTRE,
41 HUNG TO ROAD, KWUN TONG, KLN.,
HONG KONG
PHONE : 852 - 21913660
FAX : 852 - 21913990

AUSTRALIA

QualiFi Pty Ltd,
24 LIONEL ROAD,
MT. WAVERLEY VIC 3149
AUSTRALIA
PHONE : +61 - (0)3 - 9543 - 1522
FAX : +61 - (0)3 - 9543 - 3677

THAILAND

MRZ STANDARD CO., LTD
746 - 754 MAHACHAI ROAD.,
WANGBURAPAPIROM, PHRANAKORN,
BANGKOK, 10200 THAILAND
PHONE : +66 - 2 - 222 9181
FAX : +66 - 2 - 224 6795

SINGAPORE

WO KEE HONG DISTRIBUTION PTE LTD
130 JOO SENG ROAD
#03-02 OLIVINE BUILDING
SINGAPORE 368357
PHONE : +65 6858 5535 / +65 6381 8621
FAX : +65 6858 6078

NEW ZEALAND

WILDASH AUDIO SYSTEMS NZ
14 MALVERN ROAD MT ALBERT
AUCKLAND NEW ZEALAND
PHONE : +64 - 9 - 8451958
FAX : +64 - 9 - 8463554

TAIWAN

PAI- YUING CO., LTD.
6 TH FL NO, 148 SUNG KIANG ROAD,
TAIPEI, 10429, TAIWAN R.O.C.
PHONE : +886 - 2 - 25221304
FAX : +886 - 2 - 25630415

MALAYSIA

WO KEE HONG ELECTRONICS SDN. BHD.
2ND FLOOR BANGUNAN INFINITE CENTRE
LOT 1, JALAN 13/6, 46200 PETALING JAYA
SELANGOR DARUL EHSAN, MALAYSIA
PHONE : +60 - 3 - 7954 8088
FAX : +60 - 3 - 7954 7088

JAPAN Technical

MARANTZ JAPAN, INC.
35- 1, 7- CHOME, SAGAMIONO
SAGAMIHARA - SHI, KANAGAWA
JAPAN 228-8505
PHONE : +81 42 748 1013
FAX : +81 42 741 9190

日本マランツ株式会社

本社 〒228-8505
神奈川県相模原市相模大野7-35-1

KOREA

MK ENTERPRISES LTD.
ROOM 604/605, ELECTRO-OFFICETEL, 16-58,
3GA, HANGANG-RO, YONGSAN-KU, SEOUL
KOREA
PHONE : +822 - 3232 - 155
FAX : +822 - 3232 - 154

SHOCK, FIRE HAZARD SERVICE TEST :

CAUTION : After servicing this appliance and prior to returning to customer, measure the resistance between either primary AC cord connector pins (with unit NOT connected to AC mains and its Power switch ON), and the face or Front Panel of product and controls and chassis bottom.

Any resistance measurement less than 1 Megohms should cause unit to be repaired or corrected before AC power is applied, and verified before it is return to the user/customer.

Ref. UL Standard No. 1492.

In case of difficulties, do not hesitate to contact the Technical Department at above mentioned address.

1. TECHNICAL SPECIFICATIONS

TUNER SECTION

FM TUNER SECTION

| | |
|--|---|
| Tuning range | 87.5 to 108.0 MHz |
| Usable sensitivity (3% distortion) | 9.5 dB μ |
| S/N ratio | Mono: 65 dB / Stereo: 60 dB |
| T.H.D. 1kHz | Mono: 0.5% or less / Stereo: 1.0% or less |
| Output voltage | 800 mV \pm 120 mV |

AM TUNER SECTION

| | |
|---|-----------------------------------|
| Tuning range | 531 to 1602 kHz |
| Usable sensitivity (Loop antenna) | 1500 μ V/m / 63.5 dB μ /m |
| S/N ratio (400Hz/30% Modulation/10mV/m input) | 35 dB |
| T.H.D. (400Hz/30% Modulation/10mV/m input) | 1.5% or less |
| Sensitivity (\pm 9kHz) | 20 dB |
| Output voltage (400Hz 30% Modulation) | 240 mV \pm 60 mV |

DVD SECTION

AUDIO SECTION

| | |
|-------------------------------|----------------------|
| Frequency response | 20-20 kHz \pm 1 dB |
| S/N IEC-A | 90 dB |
| Dynamic range | 90 dB |
| T.H.D. | 0.01 % |
| Channel separation 1kHz | 90 dB |
| Audio output | 2.0 V \pm 1 dB |
| Digital output | 0.5 Vp-p \pm 0.05 |

VIDEO SECTION

| | |
|---|-------------------------|
| Frequency response (100IRE, Multi burst 1MHz Ref. 4.8MHz) | 6.0 dB |
| Video S/N (White100%, LPF:4.2MHz, HPF:100kHz, SC trap:ON) | 60 dB |
| Color S/N (Magenta100%, LPF:500kHz, HPF:100kHz) | 56 dB |
| Video output | 1.0 Vp-p \pm 0.8 dB |
| Video output impedance | 75 Ω |
| Y output level | 1.0 Vp-p \pm 0.1 |
| C output level | 0.286 Vp-p \pm 0.0286 |
| Y/C output impedance | 75 Ω |

GENERAL

| | |
|---|---------------------|
| Power supply | AC 230V, 50 Hz |
| Power Consumption | 18 W |
| Maximum external dimensions (W x H x D) | 210 x 71.5 x 320 mm |
| Weight | 2.8 kg |

ACCESSORIES

| | |
|-------------------------------------|---|
| Remote control unit (RC110DV) | 1 |
| Batteries (AAA type) | 2 |
| FM feeder antenna | 1 |
| Antenna plug adapter | 1 |
| AM loop antenna | 1 |
| Audio cable (Red/White) | 1 |
| Video cable (Yellow) | 1 |
| Coaxial cable (Black) | 1 |
| Remote cable (Orange) | 1 |
| Registration card | 1 |
| User's guide | 1 |

SCART CONNECTOR

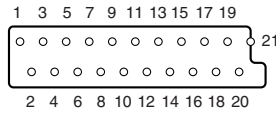

Pin No. TV (OUT)

| | |
|--------|---|
| Pin 1 | Audio R out : 2Vrms |
| Pin 2 | Audio R in : 2Vrms |
| Pin 3 | Audio L out : 2Vrms |
| Pin 4 | GND |
| Pin 5 | GND |
| Pin 6 | Audio L in : 2Vrms |
| Pin 7 | Blue out/C in Blue : 0.7Vpp ±0.1V into 75 Ohm *1 C : 300mVpp ±30 into 75 Ohm *2 |
| Pin 8 | function switching out <2V : TV >5/<8 : asp.ratio 16 : 9 DVD/AUX >9.5/<12 : asp.ratio 4 : 3 DVD/AUX |
| Pin 9 | GND |
| Pin 10 | not connected |
| Pin 11 | Green out:0.7Vpp ±0.1V into 75 Ohm *1 |
| Pin 12 | not connected |
| Pin 13 | GND |
| Pin 14 | GND |
| Pin 15 | Red/C out Red : 0.7Vpp ±0.1V into 75 Ohm *1 C : 300mVpp ±30 into 75 Ohm *2 |
| Pin 16 | fast switching out <0.4V into 75 Ohm=CVBS/S-Video 1</<3 into 75 Ohm=RGB |
| Pin 17 | GND |
| Pin 18 | GND |
| Pin 19 | CVBS/Y out : 1Vpp ±0.1V *1 |
| Pin 20 | CVBS/Y in : 1Vpp ±0.1V *1 |
| Pin 21 | GND |

Pin No. AUX (IN)

| | |
|--------|---|
| Pin 1 | Audio R out : 2Vrms |
| Pin 2 | Audio R in : 2Vrms |
| Pin 3 | Audio L out : 2Vrms |
| Pin 4 | GND |
| Pin 5 | GND |
| Pin 6 | Audio L in : 2Vrms |
| Pin 7 | Blue in/C out Blue : 0.7Vpp ±0.1V into 75 Ohm *1 C : 300mVpp ±30 into 75 Ohm *2 |
| Pin 8 | function switching in <2V : DVD >5/<8 : asp.ratio 16 : 9 AUX >9.5/<12 : asp.ratio 4 : 3 AUX |
| Pin 9 | GND |
| Pin 10 | not connected |
| Pin 11 | Green in:0.7Vpp ±0.1V into 75 Ohm |
| Pin 12 | not connected |
| Pin 13 | GND |
| Pin 14 | GND |
| Pin 15 | Red/C in Red : 0.7Vpp ±0.1V into 75 Ohm *1 C : 300mVpp ±30 into 75 Ohm *2 |
| Pin 16 | fast switching in <0.4V into 75 Ohm=CVBS/S-Video 1</<3 into 75 Ohm=RGB |
| Pin 17 | GND |
| Pin 18 | GND |
| Pin 19 | CVBS/Y out : 1Vpp ±0.1V *1 |
| Pin 20 | CVBS/Y in : 1Vpp ±0.1V *1 |
| Pin 21 | GND |

*1 : 100% White *2 : Burst Level *3 : color bar(chroma level : 75%)

REGIONAL CODES

Motion picture studios want to control the home release of movies in different countries because theater releases aren't simultaneous (a movie may come out on DVD in the US when it's just hitting screens in Europe). Therefore they have required that the DVD standard include codes which can be used to lock out the playback of certain discs in certain geographical regions. Players sold in each region will have that region's code built into the player. The player will refuse to play these "region coded" discs which are not allowed in the region. However, regional codes are entirely optional. Discs without codes will play on any player in any country. Some studios have already announced that only their new releases will have regional codes. There are six regions:



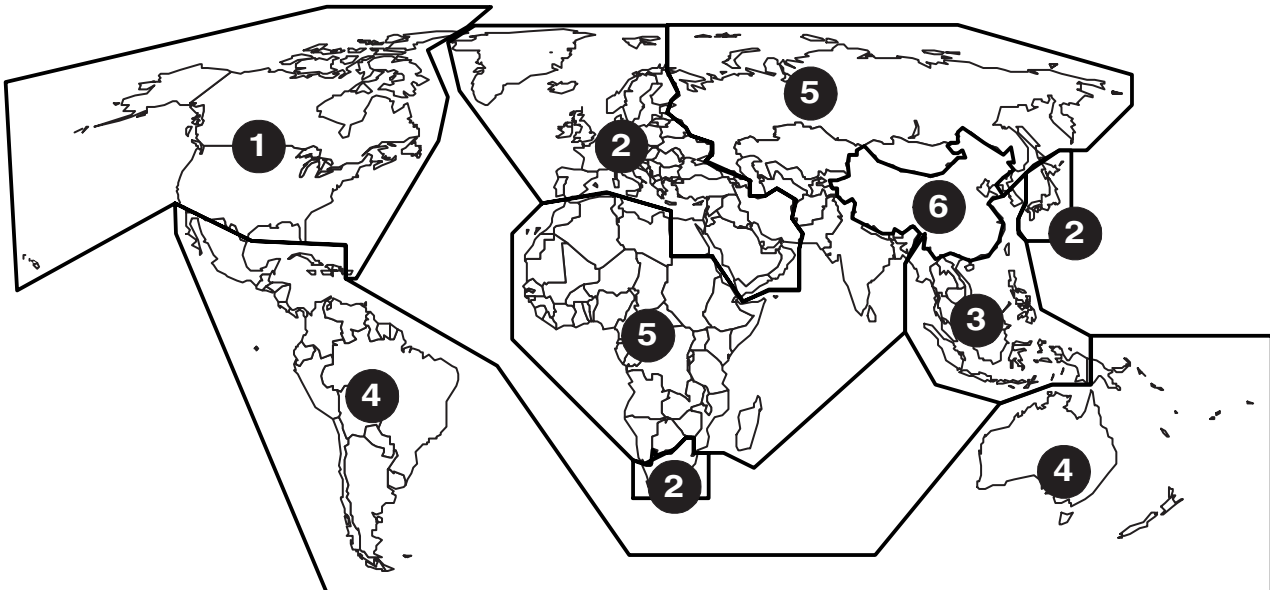

- | | |
|------------------------------------|------------------------------|
| 1. United States and Canada | 2. Europe and Japan |
| 3. Far East (except Japan & China) | 4. South America and Oceania |
| 5. Africa and the Middle East | 6. China (except Hong Kong) |



Map of DVD Regions

ABOUT DISCS

PLAYABLE DISCS

| | |
|---|--|
|  | DVD |
|  | DVD-R Finalized DVD disc recorded in the DVD video format. |
|  | Video CD (VCD) |
|  | Audio CD (CD-DA) |
|  | CD-R/CD-RW Finalized CD-R and CD-RW discs recorded in the CD-DA format, MP3 format(ISO9006), Video-CD format can be played with the unit. Nevertheless, some discs may not be able to be played depending on condition of the discs. |

* Finalize is the process to make a DVD-R or CD-R/CD-RW playable for players (not recorders)





NOT PLAYABLE DISCS

- DVD discs whose region number is not "2" nor "ALL".
- DVD-RW
- DVD-ROM
- DVD-RAM
- DVD-Audio
- DVD+RW
- CD-ROM
- CDV
- CD-G
- CVD
- Super Audio CD
- CD Photo, etc.

ABOUT DVD DISCS

Marks on packages

The marks listed below indicate contents in a disc.

| | |
|---|--|
|  | Indicates the number of recorded audio tracks. |
|  | Indicates the number of recorded subtitle languages. |
|  | Indicates the number of recorded angles. |
|  | Indicates the selectable aspect ratios. |
|  | Indicates the region number of the disc. |

2. SERVICE INFORMATION AND PROCEDURE

SERVICE HINTS

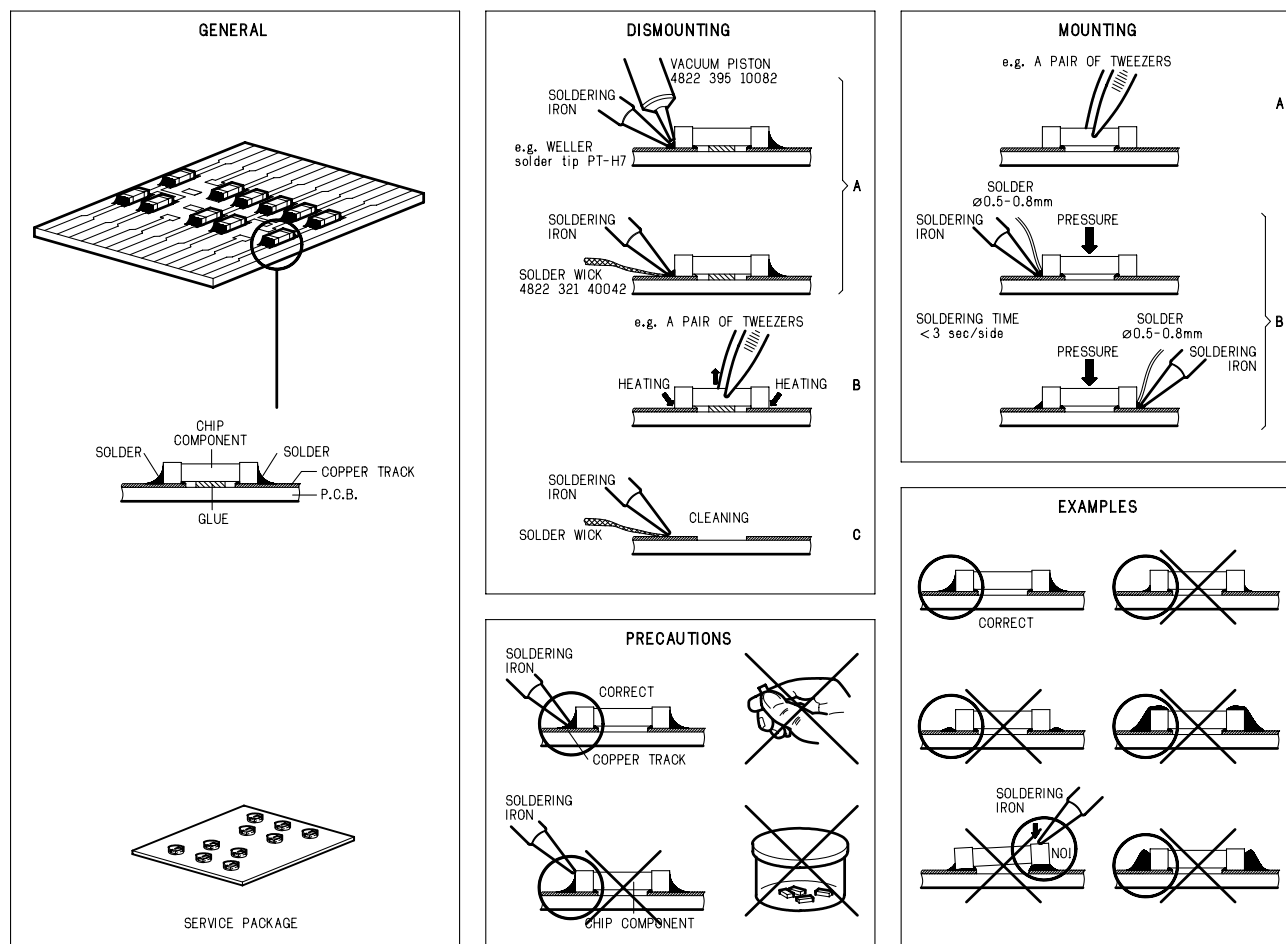

SERVICE TOOLS

Disc for firmware update

Audio signals disc

Disc without errors (SBC444)+

Disc with DO errors, black spots and fingerprints (SBC444A)

Disc (65 min 1kHz) without no pause

Max. diameter disc (58.0 mm)

Torx screwdrivers

Set (straight)

Set (square)

13th order filter

DVD test disc (PAL)

DVD test disc (NTSC) ALMEDIO

*DV110xxxx

4822 397 30184

4822 397 30245

4822 397 30155

4822 397 60141

4822 395 50145

4822 395 50132

4822 395 30204

4822 397 10131

TDV-540

WARNINGS AND LASER SAFETY INSTRUCTIONS

(GB) WARNING

All ICs and many other semi-conductors are susceptible to electrostatic discharges (ESD). Careless handling during repair can reduce life drastically.

When repairing, make sure that you are connected with the same potential as the mass of the set via a wrist wrap with resistance.

Keep components and tools also at this potential.



(NL) WAARSCHUWING

Alle IC's en vele andere halfgeleiders zijn gevoelig voor elektrostatische ontladingen (ESD).

Onzorgvuldig behandelen tijdens reparatie kan de levensduur drastisch doen verminderen.

Zorg ervoor dat u tijdens reparatie via een polsband met weerstand verbonden bent met hetzelfde potentiaal als de massa van het apparaat.

Houd componenten en hulpmiddelen ook op ditzelfde potentiaal.

(F) ATTENTION

Tous les IC et beaucoup d'autres semi-conducteurs sont sensibles aux décharges statiques (ESD).

Leur longévité pourrait être considérablement écourtée par le fait qu'aucune précaution n'est prise à leur manipulation.

Lors de réparations, s'assurer de bien être relié au même potentiel que la masse de l'appareil et enfiler le bracelet serti d'une résistance de sécurité.

Veiller à ce que les composants ainsi que les outils que l'on utilise soient également à ce potentiel.

(D) WARNUNG

Alle IC und viele andere Halbleiter sind empfindlich gegen elektrostatische Entladungen (ESD).

Unvorsichtige Behandlung bei der Reparatur kann die Lebensdauer drastisch vermindern. Sorgen Sie dafür, dass Sie im Reparaturfall über ein Pulsarmband mit Widerstand mit dem Massepotential des Gerätes verbunden sind.

Halten Sie Bauteile und Hilfsmittel ebenfalls auf diesem Potential.

(I) AVVERTIMENTO

Tutti IC e parecchi semi-conduttori sono sensibili alle scariche statiche (ESD).

La loro longevità potrebbe essere fortemente ridotta in caso di non osservazione della più grande cautela alla loro manipolazione.

Durante le riparazioni occorre quindi essere collegato allo stesso potenziale che quello della massa dell'apparecchio tramite un bracciale a resistenza.

Assicurarsi che i componenti e anche gli utensili con quali si lavora siano anche a questo potenziale.

(GB)

Safety regulations require that the set be restored to its original condition and that parts which are identical with those specified be used.

(NL)

Veiligheidsbepalingen vereisen, dat het apparaat in zijn oorspronkelijke toestand wordt terug gebracht en dat onderdelen, identiek aan de gespecificeerde worden toegepast.

(D)

Bei jeder Reparatur sind die geltenden Sicherheitsvorschriften zu beachten. Der Originalzustand des Geräts darf nicht verändert werden. Für Reparaturen sind Original-Ersatzteile zu verwenden.

(I)

Le norme di sicurezza esigono che l'apparecchio venga rimesso nelle condizioni originali e che siano utilizzati pezzi di ricambio identici a quelli specificati.

(F)

Les normes de sécurité exigent que l'appareil soit remis à l'état d'origine et que soient utilisées les pièces de rechange identiques à celles spécifiées.



SHOCK, FIRE HAZARD SERVICE TEST:

CAUTION: After servicing this appliance and prior to returning to customer, measure the resistance between either primary AC cord connector pins (with unit NOT connected to AC mains and its Power switch ON), and the face or Front Panel of product and controls and chassis bottom,

Any resistance measurement less than 1 Megohms should cause unit to be repaired or corrected before AC power is applied, and verified before return to user/customer.

Ref.UL Standard NO.1492.

NOTE ON SAFETY:

Symbol  : Fire or electrical shock hazard. Only original parts should be used to replace any part with symbol . Any other component substitution (other than original type), may increase risk of fire or electrical shock hazard.

"Pour votre sécurité, ces documents doivent être utilisés par des spécialistes agréés, seuls habilités à réparer votre appareil en panne."

LASER SAFETY

This unit employs a laser. Only a qualified service person should remove the cover or attempt to service this device, due to possible eye injury.

LASER DEVICE UNIT

Type: SemiconductorlaserGaAlAs
Wave length: 650 nm (DVD)
780 nm (VCD/CD)
Output Power: 7 mW (DVD)
10 mW (VCD/CD)
Beam divergence: 60 degree



USE OF CONTROLS OR ADJUSTMENTS OR PERFORMANCE OF PROCEDURE OTHER THAN THOSE SPECIFIED HEREIN MAY RESULT IN HAZARDOUS RADIATION EXPOSURE.

AVOID DIRECT EXPOSURE TO BEAM

WARNING

The use of optical instruments with this product will increase eye hazard.
Repair handling should take place as much as possible with a disc loaded inside the player

WARNING LOCATION: INSIDE ON LASER COVERSIELD

CAUTION VISIBLE AND INVISIBLE LASER RADIATION WHEN OPEN AVOID EXPOSURE TO BEAM
ADVARSEL SYNLIG OG USYNLIG LASERSTRÅLING VED ÅBNING UNDGÅ UDSÆTTELSE FOR STRÅLING
ADVARSEL SYNLIG OG USYNLIG LASERSTRÅLING NÅR DEKSEL ÅPNES UNNGÅ EKSPONERING FOR STRÅLEN
VARNING SYNLIG OCH OSYNLIG LASERSTRÅLNING NÅR DENNA DEL ÄR ÖPPNAD BETRAKTA EJ STRÅLEN
VARO! AVATT AESSA OLET ALTTIINA NÄKYVÄLLE JA NÄKYMÄTT ÖMÄLLE LASER SÄTEILYLLE. ÄLÄ KATSO SÄTEESEEN
VORSICHT SICHTBARE UND UNSICHTBARE LASERSTRAHLUNG WENN ABDECKUNG GEÖFFNET NICHT DEM STRAHL AUSSETZEN
DANGER VISIBLE AND INVISIBLE LASER RADIATION WHEN OPEN AVOID DIRECT EXPOSURE TO BEAM
ATTENTION RAYONNEMENT LASER VISIBLE ET INVISIBLE EN CAS D'OUVERTURE EXPOSITION DANGEREUSE AU FAISCEAU

EMERGENCY DISC EJECT

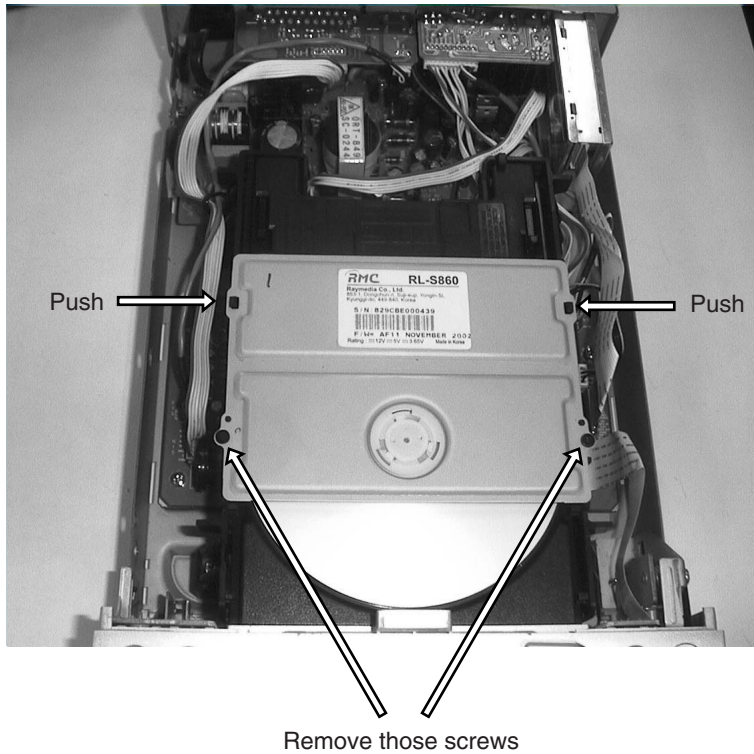

1. Remove the top cover of the player.
2. Remove two screws shown in the picture above.
3. Remove the top cover of the drive unit with pressing the latches.
4. Now you can remove the disc.

RESETTING THE UNIT

Reset all the settings EXCEPT the parental lock password

1. Pull out the Mains(AC) plug from wall outlet.
2. Keep pressing the **STAND BY** button on the front panel.
3. Insert the Mains(AC) plug to wall outlet.
4. All the settings except the parental lock password are reset.

Reset all the settings INCLUDING the parental lock password

1. Press the **OPEN/CLOSE** button to open the tray.
2. Press the **SETUP** button on the remote controller.
3. Input the code **"8800"** with the numeric buttons on the remote controller.
4. Press the **SETUP** button on the remote controller again.
5. Press the **S.TITLE** button on the remote controller.
6. All the settings including the parental lock password are reset.

FIRMWARE VERSION CHECK

Firmware version check for the main drive unit

1. First, connect a TV monitor to the player.
2. Press the **OPEN/CLOSE** button to open the tray.
3. Press the **SETUP** button on the remote controller.
4. Input the code "8800" with the numeric buttons on the remote controller.
5. Press the **SETUP** button on the remote controller again.
6. Press the **▶▶ (NEXT)** button on the remote controller.
7. The following information is displayed on the TV screen. The firmware version is shown at the top right corner.
(Ex.: B10.7.05)

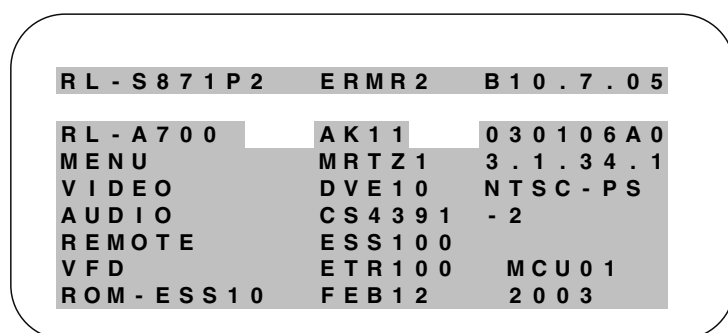

Firmware version check for the front micro-computer

1. Pull out the Mains(AC) plug from wall outlet.
2. Keep pressing the **STOP** button on the front panel.
3. Insert the Mains(AC) plug to wall outlet.
4. The firmware version is displayed on the front FLD.
(Ex.: Ver2-23)
5. Turn the MULTI JOG dial one step to either side. All the FLD segments light up then light off one by one.

FIRMWARE UPDATE

1. First, connect a TV monitor to the player.
2. Press the **STANDBY** button to turn on the unit.
3. Press the **OPEN/CLOSE** button to open the tray. Insert the update CD-ROM(Part No.: *DV110xxxx).
4. Press the **PLAY** button.
5. Firmware update will be done automatically. When updating is finished, "VERIFY DONE xxxxxx" is displayed on the TV screen. Then the disc tray opens automatically.
6. Remove the CD-ROM from the disc tray.
7. Press the **STANDBY** button to turn off the unit.
8. Press the **STANDBY** button again to turn on the unit.
9. The firmware update procedure has been completed.

Note: To check the firmware version number, follow the procedure "Firmware version check for the main drive unit" above.

3. WIRING DIAGRAM

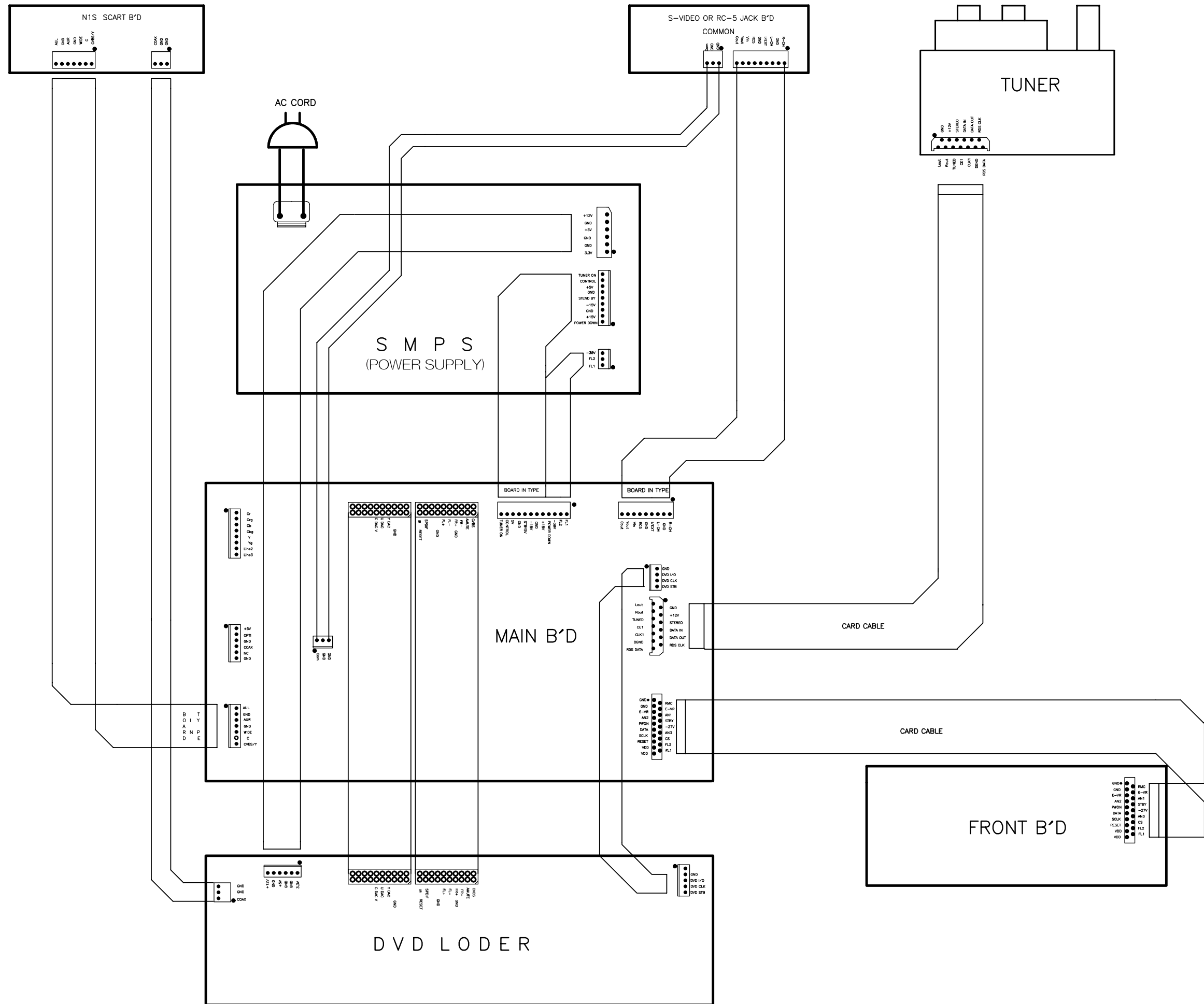

4. BLOCK DIAGRAM

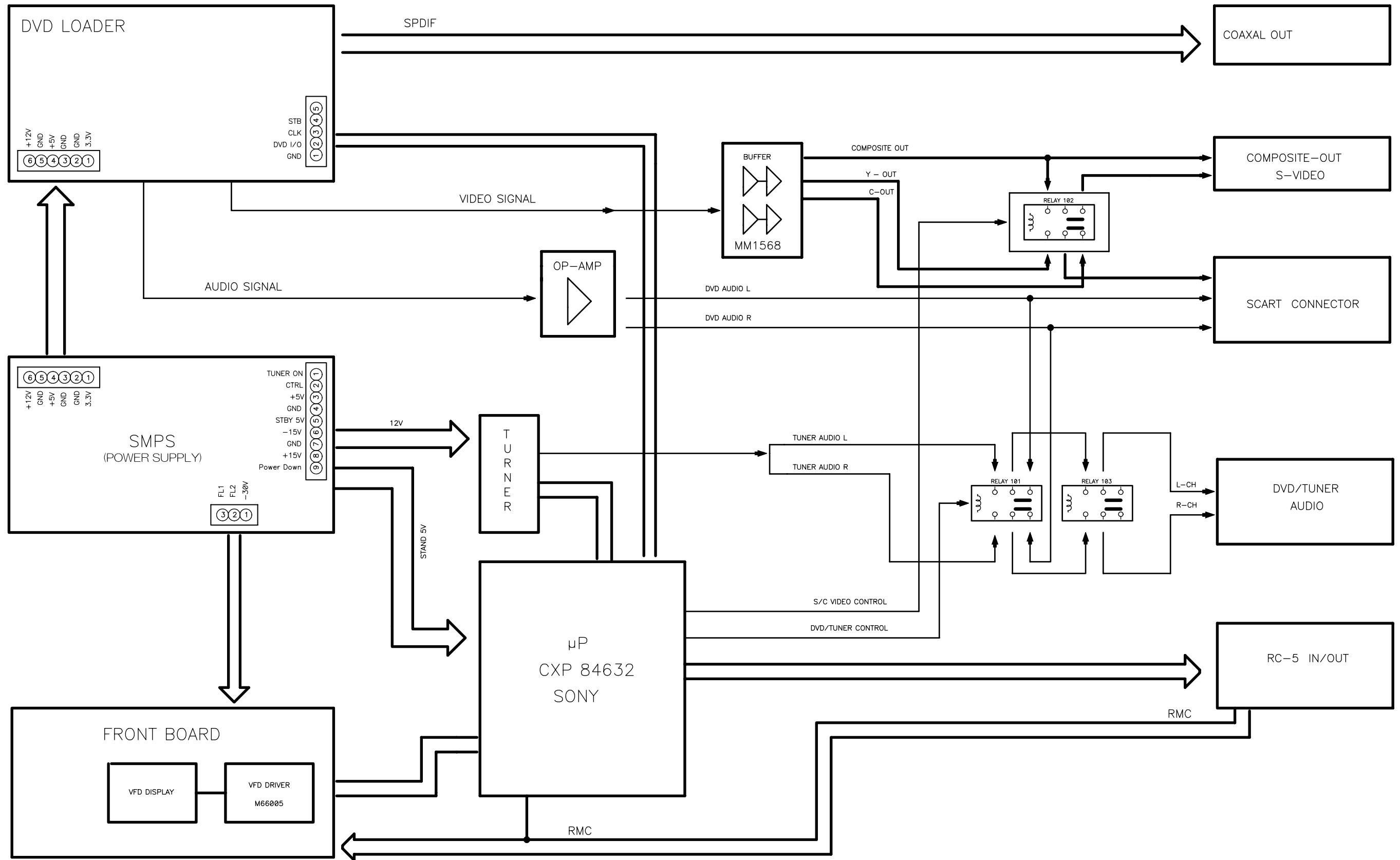

5. SCHEMATIC DIAGRAM

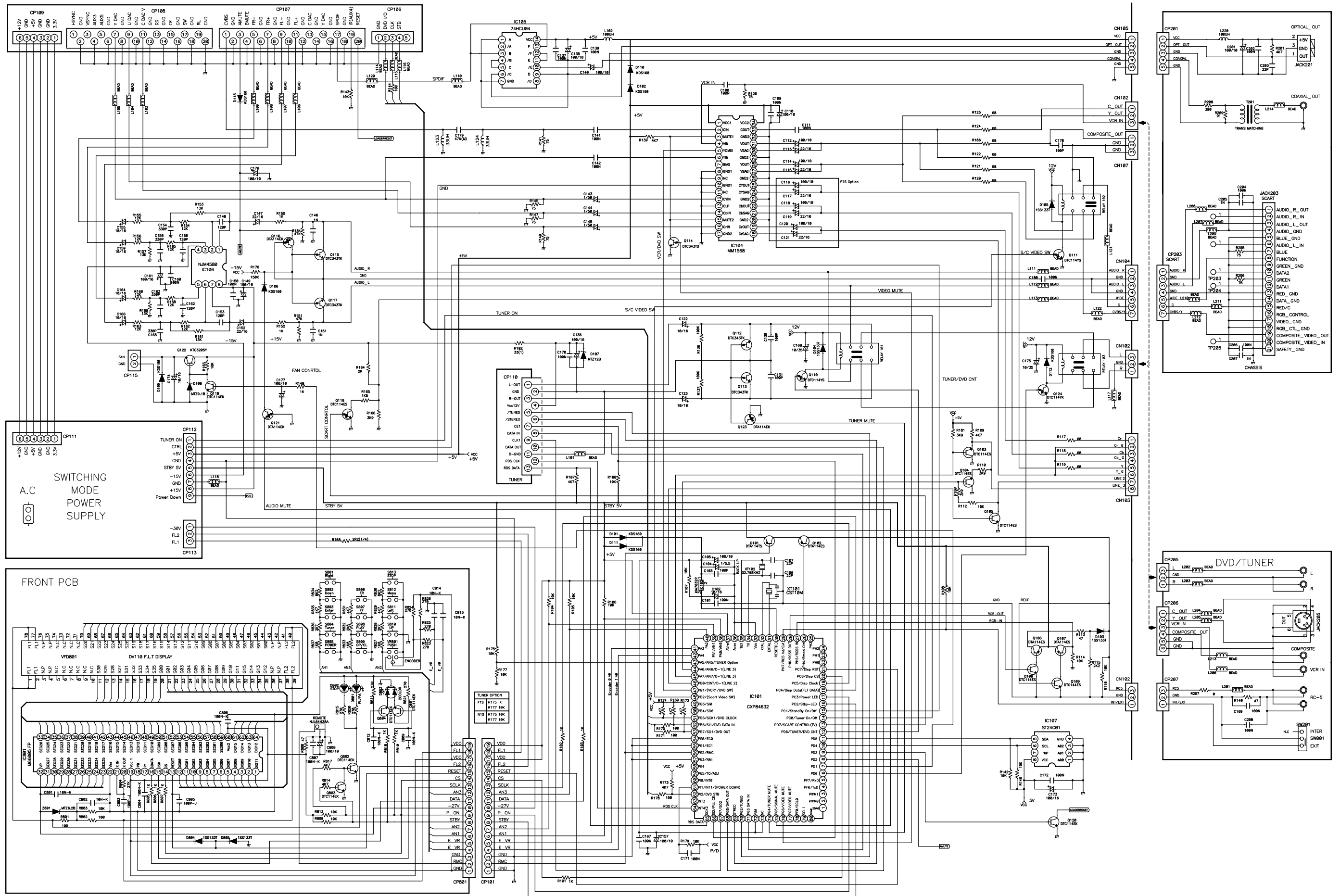

6. PARTS LOCATION

MAIN

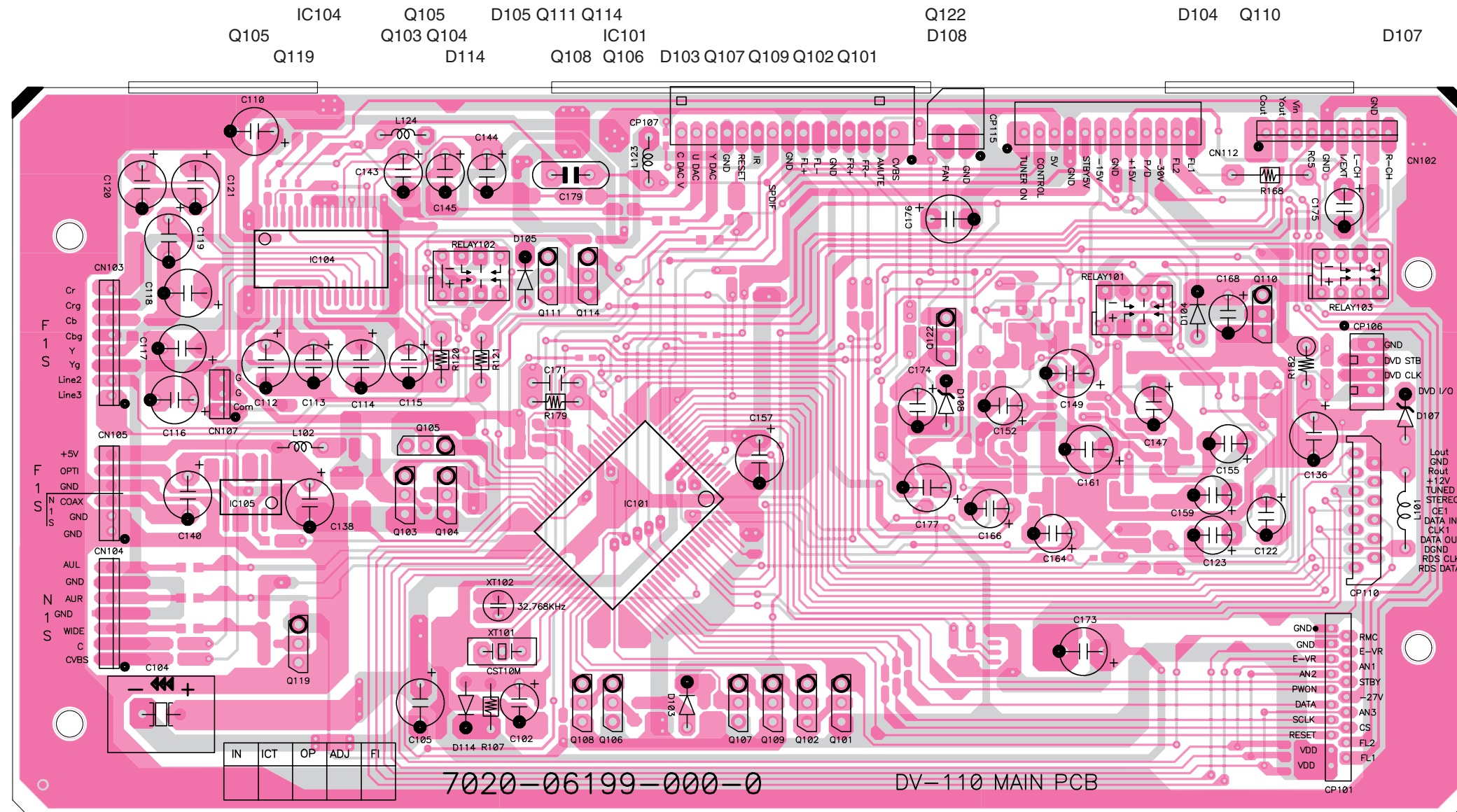

FRONT

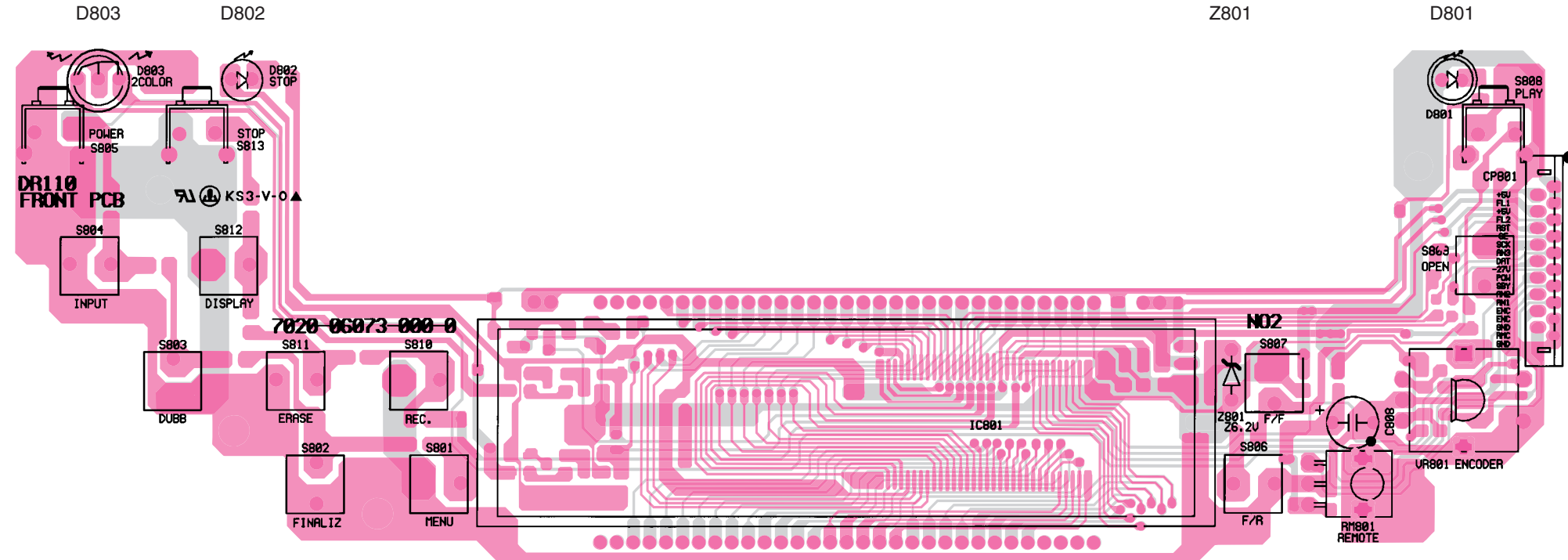

FRONT

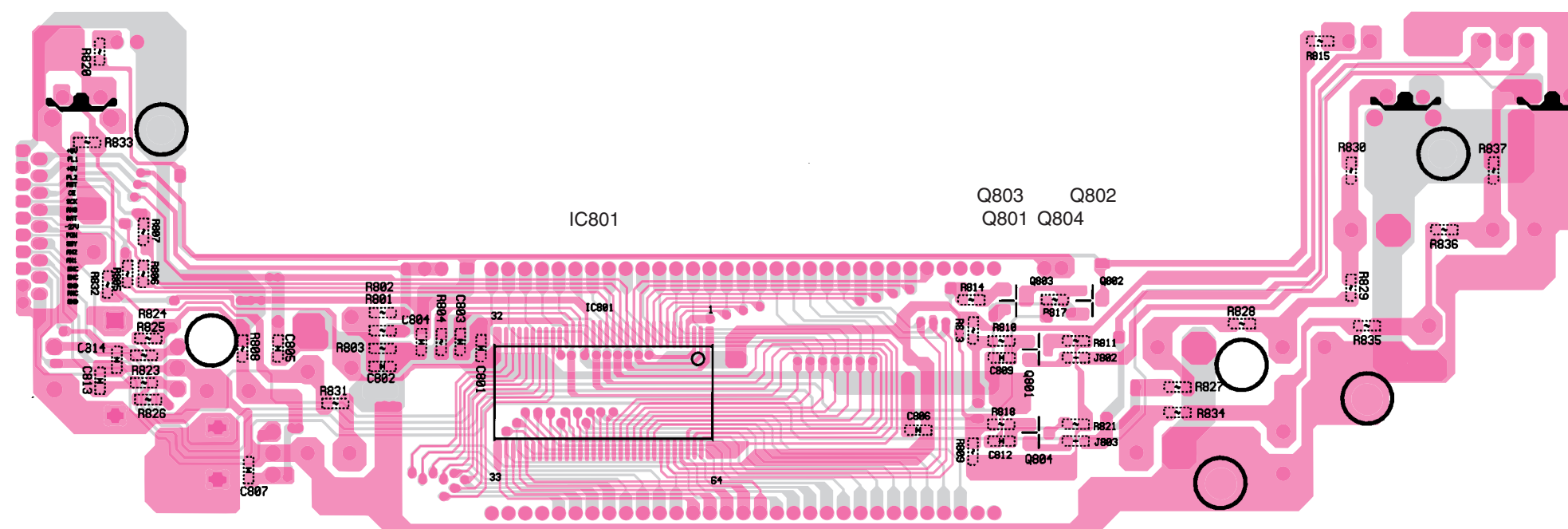

7. IC DATA

IC104:MM1568

Block Diagram

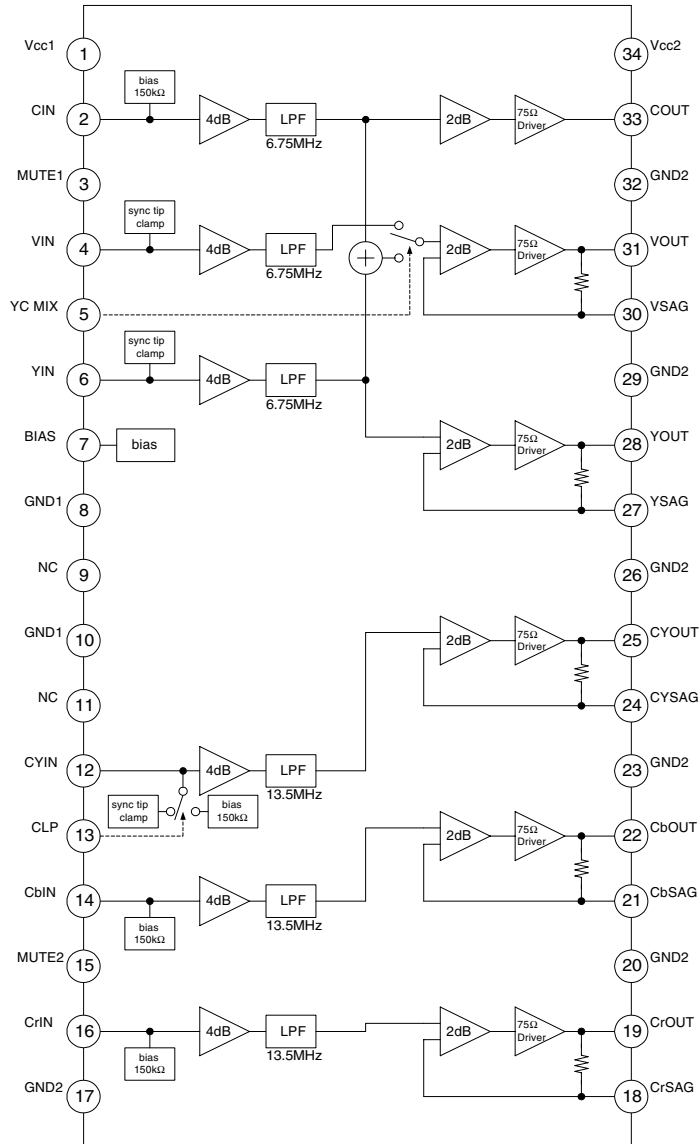

IC106:NJM4580M

Pin Assignment

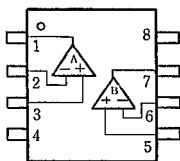

Equivalent Circuit

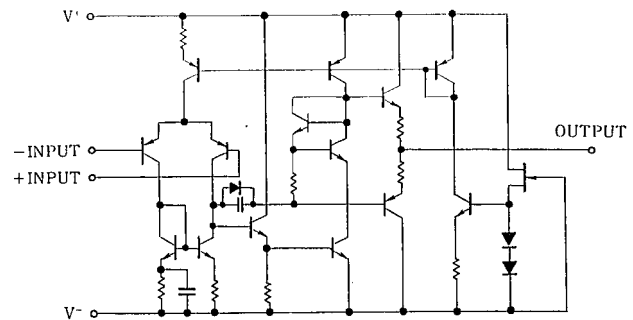

IC801:M66005FP
Pin Assignment

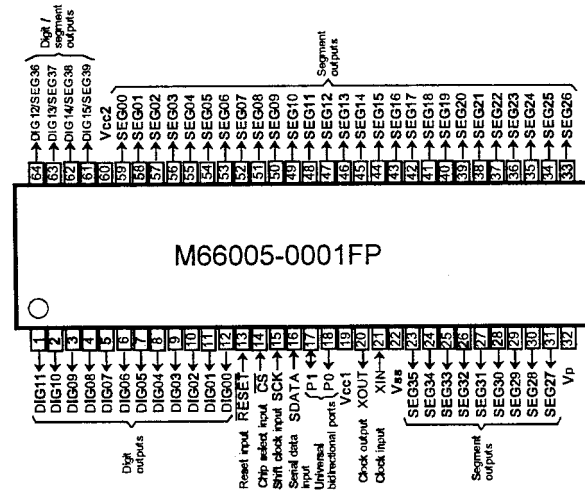

Pin Function

| Symbol | Pin name | Comment |
|-------------|---|---|
| RESET | Reset input | When "L", M66005 is initialized. |
| CS | Chip select input | When "L", communication with the MCU is possible. When "H", any instruction from the MCU is neglected. |
| SCK | Shift clock input | Serial input data is taken and shifted by the positive edge of SCK. |
| SDATA | Serial data input | |
| XIN, XOUT | Clock input Clock output | When use as a CR oscillator, connect external resistor and capacitor. When use an external clock, input external clock to XIN, and XOUT must be opened. |
| DIG00~DIG15 | Digit output | Connect to digit (grid) pins of VFD. |
| SEG00~SEG39 | Segment output | Connect to segment (anode) pins of VFD. Pins from SEG00 to SEG39 correspond to segment pins of VFD as shown in the table below. SEG36~SEG39 pins are common to DIG12~DIG15 pins. So, when use SEG36~SEG39, the number of digit to be used is decreased. |
| P1, P0 | Universal port P1 : bidirectional P0 : output | Generally, use this port as the static output port. This port also operates as the timing IN/OUT port to control another M66005. |
| Vcc1 | | Positive power supply for internal logic. |
| Vcc2 | | Positive power supply for DIG and SEG outputs. |
| Vss | | GND (0V) |
| Vp | | Negative power supply to pull down. |

VFD Grid

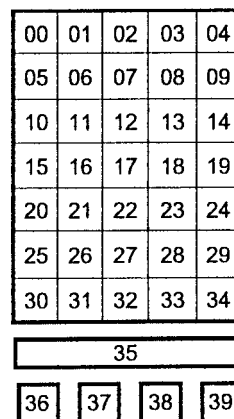

IC101:CXP84632
Pin Assignment

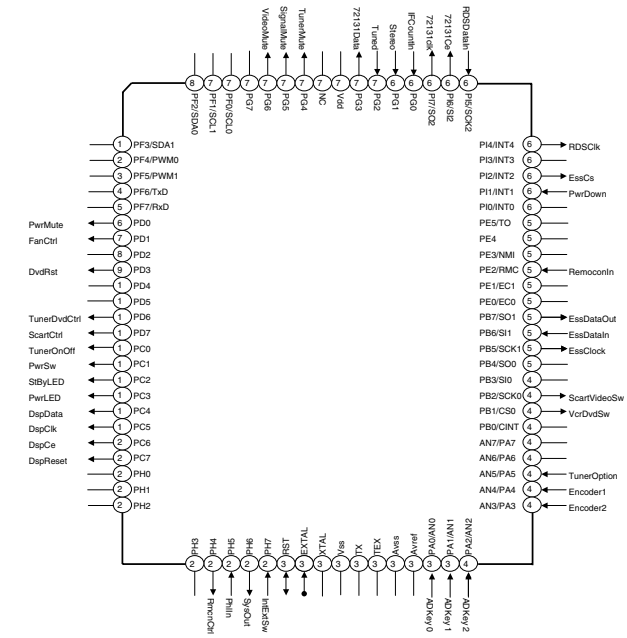

Pin Function

| Pin No | Pin Name | Act | I/O | Description |
|--------|--------------|-----|-----|---|
| 1-5 | - | - | - | Unused Pin |
| 6 | PwrMute | H/L | O | Analog Output Relay On/Off Control |
| 7 | FanCtrl | H/L | O | Fan On/Off Control |
| 8 | - | - | - | Unused Pin |
| 9 | DvdRst | H/L | O | Loader Micom Reset |
| 10-11 | - | - | - | Unused Pin |
| 12 | TunerDvdCtrl | H/L | O | Analog Output Selection(Dvd/Tuner) |
| 13 | ScartCtrl | H/L | O | Wide Port of Scart Jack Control |
| 14 | TunerOnOff | H/L | O | Loader Power On/Off Control |
| 15 | PwrSw | H/L | O | Main Power On/Off Control |
| 16 | StByLED | H/L | O | Button LED Control |
| 17 | PwrLED | H/L | O | Button LED Control |
| 18 | DspData | H/L | O | Communication Data to FL Driver IC |
| 19 | DspClk | H/L | O | Communication Clock to FL Driver IC |
| 20 | DspCe | H/L | O | Communication Chip Enable to FL Driver IC |
| 21 | DspReset | H/L | O | FI Driver IC Reset |
| 22-25 | - | - | - | Unused Pin |
| 26 | RmcnCtrl | H/L | O | Remocon Pulse Bypass Control |
| 27 | PhIn | H/L | I | RC-5/6 Read-In port |
| 28 | SysOut | H/L | O | RC-5/6 Send-Out Port |
| 29 | IntExtSw | H/L | I | Internal/External Mode Selection Check |
| 30 | RST | H/L | I | Micom Reset |
| 31 | EXTAL | H/L | I | EXTAL(10MHz) |
| 32 | XTAL | H/L | O | XTAL(10MHz) |
| 33 | Vss | L | I | GND |
| 34 | TX | H/L | O | TX(32KHz) |
| 35 | TEX | H/L | I | TEX(32KHz) |
| 36 | Avss | L | I | Analog GND |
| 37 | Avref | H | I | Analog Reference Voltage(+5V) |
| 38 | ADKey0 | A | I | Analog Key Input0 |
| 39 | ADKey1 | A | I | Analog Key Input1 |
| 40 | ADKey2 | A | I | Analog Key Input2 |
| 41 | Encoder2 | H/L | I | Encoder Pulse In 2 |
| 42 | Encoder1 | H/L | I | Encoder Pulse In1 |
| 43 | TunerOption | A | I | Tuner Option Selection Voltage |
| 44-46 | - | - | - | Unused Pin |
| 47 | VcrDvdSw | H/L | O | YCMix Selection to Video IC(MM1568) |
| 48 | ScartVideoSw | H/L | O | S-video/Composite Selection |
| 49-50 | - | - | - | Unused Pin |
| 51 | EssClock | H/L | O | Communication clock to Loader Micom |
| 52 | EssDataIn | H/L | I | Communication Data In from Loader Micom |
| 53 | EssDataOut | H/L | O | Communication Data Out to Loader Micom |
| 54-55 | - | - | - | Unused Pin |
| 56 | RemoconIn | H/L | I | Remocon Pulse In |
| 57-60 | - | - | - | Unused Pin |
| 61 | PwrDown | H/L | I | Power Down Status Check |
| 62 | EssCs | H/L | I | Communication Check From Loader Micom |
| 63 | - | - | - | Unused Pin |
| 64 | RDSClk | H/L | O | RDS Clock to Tuner Pack |
| 65 | RDSDataIn | H/L | I | RDS Data In from Tuner Pack |
| 66 | 72131Ce | H/L | O | Communication Chip Enable to Tuner Pack |
| 67 | 72131clk | H/L | O | Communication clock to Tuner Pack |
| 68 | IFCountIn | H/L | I | IF Count Pulse from Tuner Pack |
| 69 | Stereo | H/L | I | Stereo Port from TunerPack |
| 70 | Tuned | H/L | I | Tuned Port from TunerPack |
| 71 | 72131Data | H/L | O | Communication Data to TunerPack |
| 72 | Vdd | H | I | VDD |
| 73 | NC | H | I | VDD |
| 74 | TunerMute | H/L | O | Tuner Mute Control |
| 75 | Signal Mute | H/L | O | Loader Analog Signal Mute Control |
| 76 | Video Mute | H/L | O | Video Mute Control |
| 77-80 | - | - | - | Unused Pin |

8. EXPLODED VIEW AND PARTS LIST

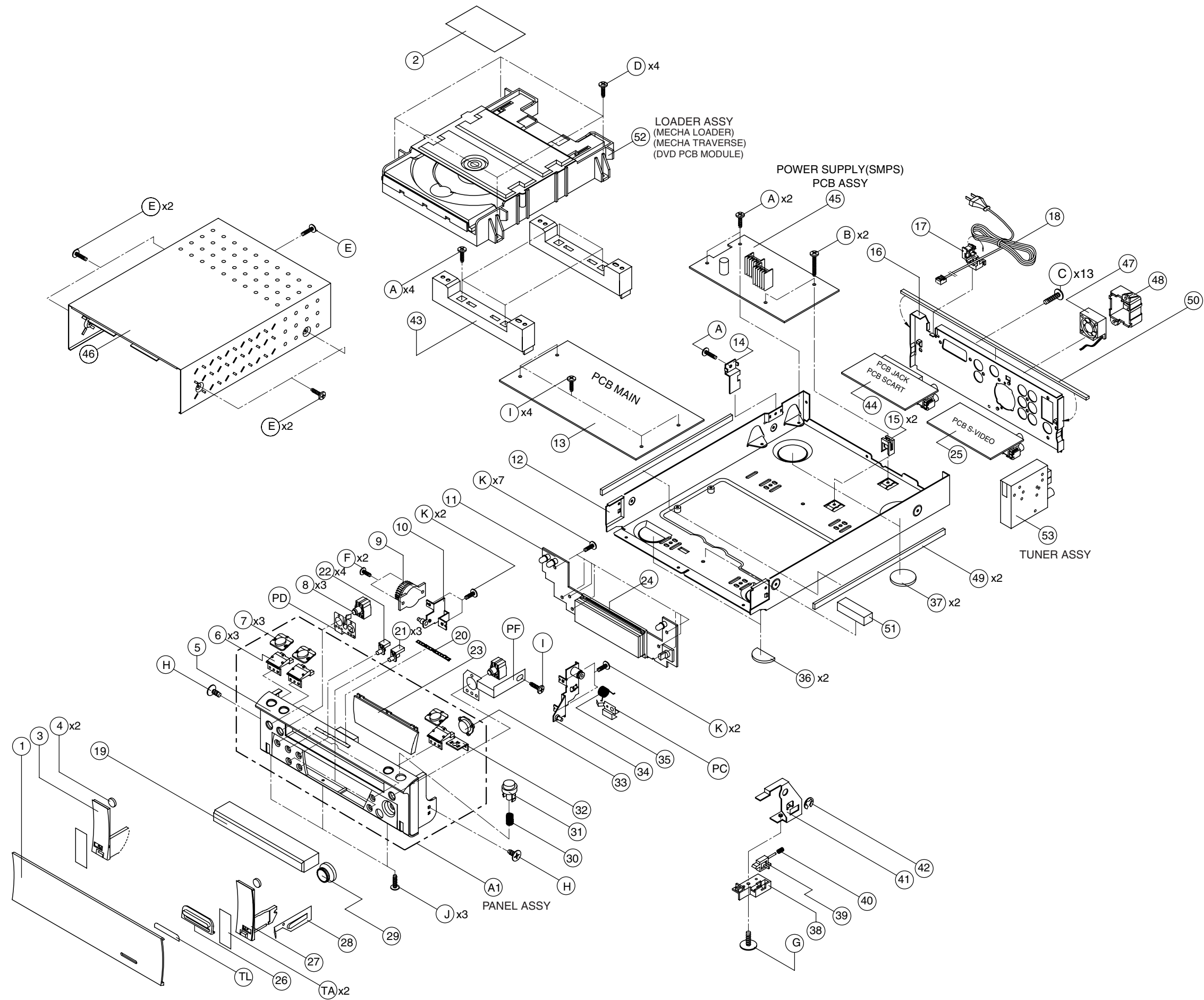

9. ELECTRICAL PARTS LIST

ASSIGNMENT OF COMMON PARTS CODES.

RESISTORS

R***: 1) GD05 x x x 140, Carbon film fixed resistor, ±5% 1/4W
 R***: 2) GD05 x x x 160, Carbon film fixed resistor, ±5% 1/6W

① Resistance value

Examples ;

① Resistance value
 0.1 Ω 001 10 Ω 100 1 kΩ 102 100 kΩ 104
 0.5 Ω 005 18 Ω 180 2.7 kΩ 272 680 kΩ 684
 1 Ω 010 100 Ω 101 10 kΩ 103 1 MΩ 105
 6.8 Ω 068 390 Ω 391 22 kΩ 223 4.7 MΩ 475

Note : Please distinguish 1/4W from 1/6W by the shape of parts used actually.

CAPACITORS

C***: CERAMIC CAP.

3) DD1 x x x x 370, Ceramic capacitor
 Disc type
 Temp.coeff.P350 ~N1000, 50V
 Capacity value
 Tolerance

Examples ;

② Tolerance (Capacity deviation)
 ±0.25 pF 0
 ±0.5 pF 1
 ±5% 5
 * Tolerance of COMMON PARTS handled here are as follows :
 0.5 pF ~ 5 pF ±0.25 pF
 6 pF ~ 10 pF ±0.5 pF
 12 pF ~ 560 pF ±5%

③ Capacity value
 0.5 pF 005 3 pF 030 100 pF 101
 1 pF 010 10 pF 100 220 pF 221
 1.5 pF 015 47 pF 470 560 pF 561

C***: CERAMIC CAP.

4) DK16 x x x 300, High dielectric constant ceramic capacitor
 Disc type
 Temp.chara. 2B4, 50V
 Capacity value

Examples ;

④ Capacity value
 100 pF 101 1000 pF 102 10000 pF 103
 470 pF 471 2200 pF 222

C***: 5) ELECTROLY CAP. (, 6) FILM CAP. ()

5) EA x x x x x 10, Electrolytic capacitor
 One-way lead type, Tolerance ±20%
 Working voltage
 Capacity value

Examples ;

⑤ Capacity value
 0.1 μF 104 4.7 μF 475 100 μF 107
 0.33 μF 334 10 μF 106 330 μF 337
 1 μF 105 22 μF 226 1100 μF 118
 2200 μF 228

⑥ Working voltage
 6.3V 006 25V 025
 10V 010 35V 035
 16V 016 50V 050

6) DF15 x x x 350 → Plastic film capacitor
 DF15 x x x 310 → One-way type, Mylar ±5% 50V
 DF16 x x x 310 → Plastic film capacitor
 One-way type, Mylar ±10% 50V
 Capacity value

Examples ;

⑦ Capacity value
 0.001 μF (1000 pF) 102 0.1 μF 104
 0.0018 μF 182 0.56 μF 564
 0.01 μF 103 1 μF 105
 0.015 μF 153

NOTE : 1) The above CODES (R***, R***, C***, C*** and C***) are omitted on the schematic diagram in some case.

2) On the occasion, be confirmed the common parts on the parts list.

3) Refer to "Common Parts List" for the other common parts (RI05, DD4, DK4).

NOTE ON SAFETY FOR FUSIBLE RESISTOR :

The suppliers and their type numbers of fusible resistors are as follows;

1. KOA Corporation

| | | |
|----------------|--------------------|-------------|
| Part No. (MJ) | Type No. (KOA) | Description |
| NH05 x x x 140 | RF25S x x x x ΩJ | (±5% 1/4W) |
| NH05 x x x 120 | RF50S x x x x ΩJ | (±5% 1/2W) |
| NH85 x x x 110 | RF73B2A x x x x ΩJ | (±5% 1/10W) |
| NH95 x x x 140 | RF73B2E x x x x ΩJ | (±5% 1/4W) |

* Resistance value Resistance value
 (0.1 Ω - 10 kΩ)

2. Matsushita Electronic Components Co., Ltd

| | | |
|----------------|----------------|-------------|
| Part No. (MJ) | Type No. (MEC) | Description |
| NF05 x x x 140 | ERD-2FCJ x x x | (±5% 1/4W) |
| RF05 x x x 140 | | |
| NF02 x x x 140 | ERD-2FCG x x x | (±2% 1/4W) |
| RF02 x x x 140 | | |

* Resistance value * Resistance value

Examples ;

* Resistance value
 0.1 Ω 001 10 Ω 100 1 kΩ 102 100 kΩ 104
 0.5 Ω 005 18 Ω 180 2.7 kΩ 272 680 kΩ 684
 1 Ω 010 100 Ω 101 10 kΩ 103 1 MΩ 105
 6.8 Ω 068 390 Ω 391 22 kΩ 223 4.7 MΩ 475



ABBREVIATION AND MARKS

| | |
|------------------------|-----------------------|
| ANT. : ANTENNA | BATT. : BATTERY |
| CAP. : CAPACITOR | CER. : CERAMIC |
| CONN. : CONNECTING | DIG. : DIGITAL |
| HP. : HEADPHONE | MIC. : MICROPHONE |
| μ-PRO : MICROPROCESSOR | REC. : RECORDING |
| RES. : RESISTOR | SPK. : SPEAKER |
| SW. : SWITCH | TRANSF. : TRANSFORMER |
| TRIM. : TRIMMING | TRS. : TRANSISTOR |
| VAR. : VARIABLE | X'TAL : CRYSTAL |

NOTE ON FUSE :

Regarding to all parts of parts code **FS20xxx2xx**, replace only with Wickmann-Werke GmbH, Type 372 non glass type fuse.

NOTE ON SAFETY :

Symbol  Fire or electrical shock hazard. Only original parts should be used to replaced any part marked with symbol . Any other component substitution (other than original type), may increase risk of fire or electrical shock hazard.

安全上の注意 :

 がついている部品は、安全上重要な部品です。必ず指定されている部品番号の部品を使用して下さい。

| POS. NO | VERS. COLOR | PART NO. (FOR EUR) | PART NO. (MJ) | DESCRIPTION |
|-----------------|-------------|--------------------|---------------------|--|
| MAIN PCB | | | | |
| C101 | nsp | DK96104300 | C,CERAMIC CHIP HIK | 0.1μF-K/50V-1608REEL D011104577160 |
| C102 | nsp | nsp | C,ELECT GE 85C | 10μF-M/16V,4*5-5RE D040100083110 |
| C103 | nsp | DD95101300 | C,CERAMIC CHIP T.C | 100pF-J/50V-1608REEL D010101167160 |
| C104 | *EX000070R | *EX000070R | C,DOUBLE LAYER(70) | IF/5.5V 5*20 D090105000010 |
| C105 | nsp | nsp | C,ELECT GE 85C | 100μF-M/10V,6.3*5-5RE SY D040101082050 |
| C106 | nsp | DD95220300 | C,CERAMIC CHIP T.C | 22pF-J/50V-1608REEL D010220167160 |
| C107 | nsp | DD95220300 | C,CERAMIC CHIP T.C | 22pF-J/50V-1608REEL D010220167160 |
| C108 | nsp | DK96104300 | C,CERAMIC CHIP HIK | 0.1μF-K/50V-1608REEL D011104577160 |
| C109 | nsp | DK96104300 | C,CERAMIC CHIP HIK | 0.1μF-K/50V-1608REEL D011104577160 |
| C110 | nsp | nsp | C,ELECT GE 85C | 100μF-M/10V,6.3*5-5RE SY D040101082050 |
| C111 | nsp | DK96104300 | C,CERAMIC CHIP HIK | 0.1μF-K/50V-1608REEL D011104577160 |
| C112 | nsp | nsp | C,ELECT GE 85C | 100μF-M/10V,6.3*5-5RE SY D040101082050 |
| C113 | nsp | nsp | C,ELECT GE 85C | 22μF-M/16V,5*5-5RE SY D040220083060 |
| C114 | nsp | nsp | C,ELECT GE 85C | 100μF-M/10V,6.3*5-5RE SY D040101082050 |
| C115 | nsp | nsp | C,ELECT GE 85C | 22μF-M/16V,5*5-5RE SY D040220083060 |
| C122 | nsp | nsp | C,ELECT GE 85C | 10μF-M/16V,4*5-5RE D040100083110 |
| C123 | nsp | nsp | C,ELECT GE 85C | 10μF-M/16V,4*5-5RE D040100083110 |
| C130 | nsp | DD95101300 | C,CERAMIC CHIP T.C | 100pF-J/50V-1608REEL D010101167160 |
| C131 | nsp | DD95101300 | C,CERAMIC CHIP T.C | 100pF-J/50V-1608REEL D010101167160 |
| C136 | nsp | nsp | C,ELECT GE 85C | 100μF-M/16V,6.3*7-5RE SY D040101083060 |
| C141 | nsp | DK96104300 | C,CERAMIC CHIP HIK | 0.1μF-K/50V-1608REEL D011104577160 |
| C142 | nsp | DK96104300 | C,CERAMIC CHIP HIK | 0.1μF-K/50V-1608REEL D011104577160 |
| C143 | nsp | nsp | C,ELECT GE 85C | 1μF-M/50V,4*7-5RE SY D040010087060 |
| C144 | nsp | nsp | C,ELECT GE 85C | 1μF-M/50V,4*7-5RE SY D040010087060 |
| C145 | nsp | nsp | C,ELECT GE 85C | 1μF-M/50V,4*7-5RE SY D040010087060 |
| C146 | nsp | DK96102300 | C,CERAMIC CHIP HIK | 1000pF-K/50V-1608REEL D011102777160 |
| C147 | nsp | nsp | C,ELECT GE 85C | 22μF-M/16V,5*5-5RE SY D040220083060 |
| C148 | nsp | DD95121300 | C,CERAMIC CHIP T.C | 120pF-J/50V-1608REEL D010121167160 |
| C149 | nsp | nsp | C,ELECT GE 85C | 100μF-M/16V,6.3*7-5RE SY D040101083060 |
| C150 | nsp | DK96104300 | C,CERAMIC CHIP HIK | 0.1μF-K/50V-1608REEL D011104577160 |
| C151 | nsp | DK96102300 | C,CERAMIC CHIP HIK | 1000pF-K/50V-1608REEL D011102777160 |
| C152 | nsp | nsp | C,ELECT GE 85C | 22μF-M/16V,5*5-5RE SY D040220083060 |
| C153 | nsp | DD95121300 | C,CERAMIC CHIP T.C | 120pF-J/50V-1608REEL D010121167160 |
| C154 | nsp | DD95331300 | C,CERAMIC CHIP T.C | 330pF-J/50V-1608REEL D010331167160 |
| C155 | nsp | nsp | C,ELECT GE 85C | 10μF-M/16V,4*5-5RE D040100083110 |
| C156 | nsp | DD95121300 | C,CERAMIC CHIP T.C | 120pF-J/50V-1608REEL D010121167160 |
| C157 | nsp | nsp | C,ELECT GE 85C | 100μF-M/10V,6.3*5-5RE SY D040101082050 |
| C158 | nsp | DD95331300 | C,CERAMIC CHIP T.C | 330pF-J/50V-1608REEL D010331167160 |
| C159 | nsp | nsp | C,ELECT GE 85C | 10μF-M/16V,4*5-5RE D040100083110 |
| C160 | nsp | DK96104300 | C,CERAMIC CHIP HIK | 0.1μF-K/50V-1608REEL D011104577160 |
| C161 | nsp | nsp | C,ELECT GE 85C | 100μF-M/16V,6.3*7-5RE SY D040101083060 |
| C162 | nsp | DD95121300 | C,CERAMIC CHIP T.C | 120pF-J/50V-1608REEL D010121167160 |
| C163 | nsp | DD95331300 | C,CERAMIC CHIP T.C | 330pF-J/50V-1608REEL D010331167160 |
| C164 | nsp | nsp | C,ELECT GE 85C | 10μF-M/16V,4*5-5RE D040100083110 |
| C165 | nsp | DD95331300 | C,CERAMIC CHIP T.C | 330pF-J/50V-1608REEL D010331167160 |
| C166 | nsp | nsp | C,ELECT GE 85C | 10μF-M/16V,4*5-5RE D040100083110 |
| C167 | nsp | DK96104300 | C,CERAMIC CHIP HIK | 0.1μF-K/50V-1608REEL D011104577160 |
| C168 | nsp | nsp | C,ELECT GE 85C | 10μF-M/35V,5*5-5RE.SY D040100085070 |
| C169 | nsp | DK96104300 | C,CERAMIC CHIP HIK | 0.1μF-K/50V-1608REEL D011104577160 |
| C170 | nsp | DK96104300 | C,CERAMIC CHIP HIK | 0.1μF-K/50V-1608REEL D011104577160 |
| C171 | nsp | nsp | C,CERAMIC HIK AXIAL | 0.1μF-Z/50V-52RE D005104597530 |
| C174 | nsp | nsp | C,ELECT GE 85C | 10μF-M/16V,4*5-5RE D040100083110 |
| C175 | nsp | nsp | C,ELECT GE 85C | 10μF-M/35V,5*5-5RE.SY D040100085070 |
| C176 | nsp | nsp | C,ELECT GE 85C | 100μF-M/10V,6.3*5-5RE SY D040101082050 |
| C177 | nsp | nsp | C,ELECT GE 85C | 100μF-M/10V,6.3*5-5RE SY D040101082050 |
| C178 | nsp | DD95101300 | C,CERAMIC CHIP T.C | 100pF-J/50V-1608REEL D010101167160 |
| C179 | nsp | nsp | C,FILM POLYESTER | 0.047μF-J/50V-5RE D020473167050 |
| CN102 | nsp | nsp | CN,WIRE | 160MM 9P A2004H00-9=B2011H02-9 L000161090030 |
| CN104 | nsp | nsp | CN,WIRE | 310MM 7P A2004H00-7=B2011H02-7 L000311070010 |
| CN107 | nsp | nsp | CN,WIRE | 340MM/3P A2004H00-3=B2011H02-3 L000341030050 |
| CN112 | nsp | nsp | CN,WIRE | 110/12P B2011-12=GIL-S-3P+9P L000111120010 |
| CP101 | nsp | nsp | CN.FPC 1.0MM | SCB 2119-00 19P ST L130211900010 |
| CP106 | nsp | nsp | CN.WAFER 2.0MM | 53014-0410 4P L101530140410 |

NOTE : "nsp" PART IS LISTED FOR REFERENCE ONLY, MARANTZ WILL NOT SUPPLY THESE PARTS.

| POS. NO | VERS. COLOR | PART NO. (FOR EUR) | PART NO. (MJI) | DESCRIPTION | | |
|---------|-------------|--------------------|----------------|----------------------|------------------------------|---------------|
| CP107 | | nsp | nsp | CN.WAFER 2.0MM | 53015-1510 15P ANGLE | L101530151510 |
| CP110 | | nsp | nsp | CN.FPC 1.25MM | 8370-131 13P ST | L131837001300 |
| CP115 | | nsp | nsp | CN.WAFER 2.5MM | 5268-02A 2P ANGLE | L102526800200 |
| D101 | | nsp | *HD201560R | D,SWITCHING CHIP | KDS160(μF) /USC | K005016000010 |
| D103 | | nsp | *HD201720R | D,SWITCHING | 1N4148-52RE 75V 150MA DO-34 | K000414803520 |
| D104 | | nsp | *HD201720R | D,SWITCHING | 1N4148-52RE 75V 150MA DO-34 | K000414803520 |
| D105 | | nsp | *HD201720R | D,SWITCHING | 1N4148-52RE 75V 150MA DO-34 | K000414803520 |
| D106 | | nsp | *HD201560R | D,SWITCHING CHIP | KDS160(μF) /USC | K005016000010 |
| D107 | | *HD302160R | *HD302160R | D,ZENER | MTZJ12B-0.5W/5MA-52MM | K06012R044520 |
| D108 | | *HD301970R | *HD301970R | D,ZENER | MTZJ9.1B-0.5W/5MA-52MM | K06009R144520 |
| D109 | | nsp | *HD201560R | D,SWITCHING CHIP | KDS160(μF) /USC | K005016000010 |
| D112 | | nsp | *HD201560R | D,SWITCHING CHIP | KDS160(μF) /USC | K005016000010 |
| D112 | | nsp | *HD201720R | D,SWITCHING | 1N4148-52RE 75V 150MA DO-34 | K000414803520 |
| D113 | | nsp | *HD201560R | D,SWITCHING CHIP | KDS160(μF) /USC | K005016000010 |
| IC101 | | *HU100650R | *HU100650R | IC,CPU MICRO PROCESS | CXP84632-315Q QFP80 DWP-372 | J020846323150 |
| IC104 | | *HC108290R | *HC108290R | IC,LINEAR-DRIVER | MM1568AJBE/DRIVER SSOP34 | J127156800010 |
| IC106 | | *HC400050R | *HC400050R | IC,LINEAR OP | NJM4580M-SOP8P | J121458000040 |
| L101 | | *FC900310R | *FC900310R | BEAD,COIL | PI3.5*5MM 52RE | 7610000020520 |
| L103 | | | | | | |
| ∫ | | *FC900290R | *FC900290R | BEAD,COIL CHIP | HB-IT2012-121JT 2012REEL | 7611010000020 |
| L122 | | | | | | |
| L123 | | nsp | nsp | COIL,FILTER-INDUCTOR | 33UH-Q40/14M-R4.7-52RE | D330330700520 |
| L124 | | nsp | nsp | COIL,FILTER-INDUCTOR | 33UH-Q40/14M-R4.7-52RE | D330330700520 |
| Q101 | | *BA001340R | *BA001340R | SEMI,BRT/PNP RA | DTA114TS,0.3W/TO92M-REEL | J6000114T0010 |
| Q102 | | BA10007210 | BA10007210 | SEMI,BRT/PNP RA | DTA114ES,0.3W/TO92M-REEL | J6000114E0010 |
| Q106 | | BA10007210 | BA10007210 | SEMI,BRT/PNP RA | DTA114ES,0.3W/TO92M-REEL | J6000114E0010 |
| Q107 | | BA10007210 | BA10007210 | SEMI,BRT/PNP RA | DTA114ES,0.3W/TO92M-REEL | J6000114E0010 |
| Q108 | | *BA001350R | *BA001350R | SEMI,BRT/NPN RC | DTC114ES,0.3W/TO92M-REEL | J6020114E0010 |
| Q109 | | *BA001390R | *BA001390R | SEMI,BRT/NPN RC | DTC114ES,0.3W/TO92M-REEL | J6020144E0010 |
| Q110 | | *BA001360R | *BA001360R | SEMI,BRT/NPN RC | DTC114YS,0.3W/TO92M-REEL | J6020114Y0050 |
| Q111 | | *BA001360R | *BA001360R | SEMI,BRT/NPN RC | DTC114YS,0.3W/TO92M-REEL | J6020114Y0050 |
| Q112 | | *BA001470R | *BA001470R | TRS.CHIP/NPN 2SC | DTC343TK(H03) 0.2W/SMT-REEL | J5220343T0210 |
| Q113 | | *BA001470R | *BA001470R | TRS.CHIP/NPN 2SC | DTC343TK(H03) 0.2W/SMT-REEL | J5220343T0210 |
| Q114 | | *BA001480R | *BA001480R | SEMI,BRT/NPN RC | DTC343TS,0.3W/TO92M-REEL | J6020343T0010 |
| Q115 | | *BA001470R | *BA001470R | TRS.CHIP/NPN 2SC | DTC343TK(H03) 0.2W/SMT-REEL | J5220343T0210 |
| Q116 | | BA10023210 | BA10023210 | TRS.CHIP/PNP 2SA | DTA114EK(14) 0.2W/SMT-REEL | J5200114E0210 |
| Q117 | | *BA001470R | *BA001470R | TRS.CHIP/NPN 2SC | DTC343TK(H03) 0.2W/SMT-REEL | J5220343T0210 |
| Q118 | | BA20005210 | BA20005210 | TRS.CHIP/NPN 2SC | DTC114EK(24),0.2W/SMT-REEL | J5220114E0210 |
| Q119 | | *BA001350R | *BA001350R | SEMI,BRT/NPN RC | DTC114ES,0.3W/TO92M-REEL | J6020114E0010 |
| Q120 | | BA20005210 | BA20005210 | TRS.CHIP/NPN 2SC | DTC114EK(24),0.2W/SMT-REEL | J5220114E0210 |
| Q121 | | BA10023210 | BA10023210 | TRS.CHIP/PNP 2SA | DTA114EK(14) 0.2W/SMT-REEL | J5200114E0210 |
| Q122 | | *BA001260R | *BA001260R | SEMI,TR/GE NPN 2SC | KTC3205Y,1W/TO92L-REEL | J5023205Y0020 |
| Q123 | | BA10023210 | BA10023210 | TRS.CHIP/PNP 2SA | DTA114EK(14) 0.2W/SMT-REEL | J5200114E0210 |
| Q124 | | BA20007210 | BA20007210 | TRS.CHIP/NPN 2SC | DTC114YK (64),0.2W/SMT-REEL | J5220114Y0210 |
| R101 | | nsp | NN05102610 | R,CHIP THICK | 1k-J,1/16W-1608REEL | C20001026M160 |
| R102 | | nsp | NN05102610 | R,CHIP THICK | 1k-J,1/16W-1608REEL | C20001026M160 |
| R103 | | nsp | NN05102610 | R,CHIP THICK | 1k-J,1/16W-1608REEL | C20001026M160 |
| R104 | | nsp | NN05103610 | R,CHIP THICK | 10k-J,1/16W-1608REEL | C20001036M160 |
| R105 | | nsp | NN05103610 | R,CHIP THICK | 10k-J,1/16W-1608REEL | C20001036M160 |
| R106 | | nsp | NN05103610 | R,CHIP THICK | 10k-J,1/16W-1608REEL | C20001036M160 |
| R107 | | nsp | nsp | R,CARBON FILM | 100k-J,1/5W-52RE-AX | C00001046P520 |
| R108 | | nsp | NN05103610 | R,CHIP THICK | 10k-J,1/16W-1608REEL | C20001036M160 |
| R113 | | nsp | NN05470610 | R,CHIP THICK | 47-J,1/16W-1608REEL | C20004706M160 |
| R114 | | nsp | NN05103610 | R,CHIP THICK | 10k-J,1/16W-1608REEL | C20001036M160 |
| R115 | | nsp | NN05222610 | R,CHIP THICK | 2.2k-J,1/16W-1608REEL | C20002226M160 |
| R116 | | nsp | NN05103610 | R,CHIP THICK | 10k-J,1/16W-1608REEL | C20001036M160 |
| R120 | | nsp | nsp | R,FIXED,CARBON FILM | RD-T-1/6WJ-68 1.9*3.2 52REEL | N111112668010 |
| R121 | | nsp | nsp | R,FIXED,CARBON FILM | RD-T-1/6WJ-68 1.9*3.2 52REEL | N111112668010 |
| R122 | | nsp | NN05680610 | R,CHIP THICK | 68-J,1/16W-1608REEL | C20006806M160 |
| R124 | | nsp | NN05680610 | R,CHIP THICK | 68-J,1/16W-1608REEL | C20006806M160 |
| R125 | | nsp | NN05680610 | R,CHIP THICK | 68-J,1/16W-1608REEL | C20006806M160 |
| R126 | | nsp | NN05750610 | R,CHIP THICK | 75-J,1/16W-1608REEL | C20007506M160 |
| R127 | | nsp | NN05000610 | R,CHIP THICK | 0-J,1/16W-1608REEL | C20000006M160 |
| R136 | | nsp | NN05104610 | R,CHIP THICK | 100k-J,1/16W-1608REEL | C20001046M160 |

NOTE : *nsp* PART IS LISTED FOR REFERENCE ONLY, MARANTZ WILL NOT SUPPLY THESE PARTS.

| POS. NO | VERS. COLOR | PART NO. (FOR EUR) | PART NO. (MJI) | DESCRIPTION | | |
|---------|-------------|--------------------|----------------|---------------------|-------------------------------|---------------|
| R137 | | nsp | NN05104610 | R,CHIP THICK | 100k-J,1/16W-1608REEL | C20001046M160 |
| R139 | | nsp | NN05472610 | R,CHIP THICK | 4.7k-J,1/16W-1608REEL | C20004726M160 |
| R141 | | nsp | NN05750610 | R,CHIP THICK | 75-J,1/16W-1608REEL | C20007506M160 |
| R143 | | nsp | NN05103610 | R,CHIP THICK | 10k-J,1/16W-1608REEL | C20001036M160 |
| R144 | | nsp | NN05101610 | R,CHIP THICK | 100-J,1/16W-1608REEL | C20001016M160 |
| R145 | | nsp | NN05750610 | R,CHIP THICK | 75-J,1/16W-1608REEL | C20007506M160 |
| R147 | | nsp | NN05750610 | R,CHIP THICK | 75-J,1/16W-1608REEL | C20007506M160 |
| R148 | | nsp | NN05102610 | R,CHIP THICK | 1k-J,1/16W-1608REEL | C20001026M160 |
| R149 | | nsp | NN05750610 | R,CHIP THICK | 75-J,1/16W-1608REEL | C20007506M160 |
| R150 | | nsp | NN05102610 | R,CHIP THICK | 1k-J,1/16W-1608REEL | C20001026M160 |
| R151 | | nsp | NN05473610 | R,CHIP THICK | 47k-J,1/16W-1608REEL | C20004736M160 |
| R152 | | nsp | NN05102610 | R,CHIP THICK | 1k-J,1/16W-1608REEL | C20001026M160 |
| R153 | | nsp | NN05133610 | R,CHIP THICK | 13k-J,1/16W-1608REEL | C20001336M160 |
| R154 | | nsp | NN05123610 | R,CHIP THICK | 12k-J,1/16W-1608REEL | C20001236M160 |
| R155 | | nsp | NN05123610 | R,CHIP THICK | 12k-J,1/16W-1608REEL | C20001236M160 |
| R156 | | nsp | NN05123610 | R,CHIP THICK | 12k-J,1/16W-1608REEL | C20001236M160 |
| R157 | | nsp | NN05133610 | R,CHIP THICK | 13k-J,1/16W-1608REEL | C20001336M160 |
| R158 | | nsp | NN05123610 | R,CHIP THICK | 12k-J,1/16W-1608REEL | C20001236M160 |
| R159 | | nsp | NN05133610 | R,CHIP THICK | 13k-J,1/16W-1608REEL | C20001336M160 |
| R160 | | nsp | NN05123610 | R,CHIP THICK | 12k-J,1/16W-1608REEL | C20001236M160 |
| R161 | | nsp | NN05133610 | R,CHIP THICK | 13k-J,1/16W-1608REEL | C20001336M160 |
| R162 | | nsp | NN05123610 | R,CHIP THICK | 12k-J,1/16W-1608REEL | C20001236M160 |
| R163 | | nsp | NN05123610 | R,CHIP THICK | 12k-J,1/16W-1608REEL | C20001236M160 |
| R164 | | nsp | NN05202610 | R,CHIP THICK | 2k-J,1/16W-1608REEL | C20002026M160 |
| R165 | | nsp | NN05152610 | R,CHIP THICK | 1.5k-J,1/16W-1608REEL | C20001526M160 |
| R166 | | nsp | NN05392610 | R,CHIP THICK | 3.9k-J,1/16W-1608REEL | C20003926M160 |
| R168 | | nsp | nsp | R,CARBON FILM | 2.2-J,1/4W-52RE-AX | C0002R2063520 |
| R169 | | nsp | NN05472610 | R,CHIP THICK | 4.7k-J,1/16W-1608REEL | C20004726M160 |
| R170 | | nsp | NN05101610 | R,CHIP THICK | 100-J,1/16W-1608REEL | C20001016M160 |
| R171 | | nsp | NN05101610 | R,CHIP THICK | 100-J,1/16W-1608REEL | C20001016M160 |
| R172 | | nsp | NN05472610 | R,CHIP THICK | 4.7k-J,1/16W-1608REEL | C20004726M160 |
| R173 | | nsp | NN05472610 | R,CHIP THICK | 4.7k-J,1/16W-1608REEL | C20004726M160 |
| R174 | | nsp | NN05472610 | R,CHIP THICK | 4.7k-J,1/16W-1608REEL | C20004726M160 |
| R175 | | nsp | NN05103610 | R,CHIP THICK | 10k-J,1/16W-1608REEL | C20001036M160 |
| R176 | | nsp | NN05154610 | R,CHIP THICK | 150k-J,1/16W-1608REEL | C20001546M160 |
| R177 | | nsp | NN05103610 | R,CHIP THICK | 10k-J,1/16W-1608REEL | C20001036M160 |
| R178 | | nsp | NN05101610 | R,CHIP THICK | 100-J,1/16W-1608REEL | C20001016M160 |
| R179 | | nsp | nsp | R,FIXED,CARBON FILM | RD-T-1/6WJ-10K 1.9*3.2 52REEL | N111112610310 |
| R182 | | nsp | nsp | R,FIXED,METAL | RSS-RT-1WJ-33 2.6*6.2(MAX) | N112135633011 |
| R183 | | nsp | NN05103610 | R,CHIP THICK | 10k-J,1/16W-1608REEL | C20001036M160 |
| R184 | | nsp | NN05473610 | R,CHIP THICK | 47k-J,1/16W-1608REEL | C20004736M160 |
| R185 | | nsp | NN05123610 | R,CHIP THICK | 12k-J,1/16W-1608REEL | C20001236M160 |
| R186 | | nsp | NN05680610 | R,CHIP THICK | 68-J,1/16W-1608REEL | C20006806M160 |
| R187 | | nsp | NN05472610 | R,CHIP THICK | 4.7k-J,1/16W-1608REEL | C20004726M160 |
| R188 | | nsp | NN05103610 | R,CHIP THICK | 10k-J,1/16W-1608REEL | C20001036M160 |
| | RELAY101 | *LY000350R | *LY000350R | RELAY | SG-G6K2P-001A DC12V | G680120102010 |
| | RELAY102 | *LY000350R | *LY000350R | RELAY | SG-G6K2P-001A DC12V | G680120102010 |
| | RELAY103 | *LY000350R | *LY000350R | RELAY | SG-G6K2P-001A DC12V | G680120102010 |
| XT101 | | *FQ000350R | *FQ000350R | RESONATOR,CERAMIC | CST10.0MTW-TF01/REEL | E830100000050 |
| XT102 | | *JX000830R | *JX000830R | CRYSTAL | X-TAL MX-38T(32.768KHZ) NDK | E800327680050 |
| | | | | FRONT PCB | | |
| C801 | | nsp | DK96103300 | C,CERAMIC CHIP HIK | 0.01µF-K/50V-1608REEL | D011103777160 |
| C802 | | nsp | DK96103300 | C,CERAMIC CHIP HIK | 0.01µF-K/50V-1608REEL | D011103777160 |
| C803 | | nsp | DD95101300 | C,CERAMIC CHIP T.C | 100pF-J/50V-1608REEL | D010101167160 |
| C804 | | | | | | |
| } | | nsp | DK96104300 | C,CERAMIC CHIP HIK | 0.1µF-K/50V-1608REEL | D011104577160 |
| C807 | | | | | | |
| C808 | | nsp | nsp | C,ELECT GE 85C | 100µF-M/10V,6.3*5-5RE SY | D040101082050 |
| C809 | | nsp | DK96104300 | C,CERAMIC CHIP HIK | 0.1µF-K/50V-1608REEL | D011104577160 |
| C812 | | nsp | DK96104300 | C,CERAMIC CHIP HIK | 0.1µF-K/50V-1608REEL | D011104577160 |
| C813 | | nsp | DK96103300 | C,CERAMIC CHIP HIK | 0.01µF-K/50V-1608REEL | D011103777160 |
| C814 | | nsp | DK96103300 | C,CERAMIC CHIP HIK | 0.01µF-K/50V-1608REEL | D011103777160 |
| CP801 | | nsp | nsp | CN.FPC 1.0MM | SCB 2119-00 19P ST | L130211900010 |

NOTE : *nsp* PART IS LISTED FOR REFERENCE ONLY, MARANTZ WILL NOT SUPPLY THESE PARTS.

| POS. NO | VERS. COLOR | PART NO. (FOR EUR) | PART NO. (MJI) | DESCRIPTION | | |
|---------|-------------|--------------------|----------------|---------------------|------------------------------|---------------|
| D801 | | *HI100970R | *HI100970R | LED,ROUND | HL-50CDG GREEN MILKY RESIN | K50000020010 |
| D802 | | *HI100970R | *HI100970R | LED,ROUND | HL-50CDG GREEN MILKY RESIN | K50000020010 |
| D803 | | *HI100980R | *HI100980R | LED,ROUND | PI5-RD,GR/HLD50RG,DUAL | K500052003090 |
| D804 | | nsp | *HD201580R | D,SWITCHING CHIP | 1SS355USM(A) | K005035500010 |
| D805 | | nsp | *HD201580R | D,SWITCHING CHIP | 1SS355USM(A) | K005035500010 |
| IC801 | | *HC107180R | *HC107180R | IC,LINEAR-DRIVER | M66005FP-SOP64P /FL DRIVER | J127660050010 |
| J802 | | nsp | NN05000610 | R,CHIP THICK | 0-J,1/16W-1608REEL | C20000006M160 |
| J803 | | nsp | NN05000610 | R,CHIP THICK | 0-J,1/16W-1608REEL | C20000006M160 |
| Q801 | | | | | | |
| ∫ | | BA20005210 | BA20005210 | TRS.CHIP/NPN 2SC | DTC114EK(24),0.2W/SMT-REEL | J5220114E0210 |
| Q804 | | | | | | |
| R801 | | nsp | NN05101610 | R,CHIP THICK | 100-J,1/16W-1608REEL | C20001016M160 |
| R802 | | nsp | NN05101610 | R,CHIP THICK | 100-J,1/16W-1608REEL | C20001016M160 |
| R803 | | nsp | NN05103610 | R,CHIP THICK | 10k-J,1/16W-1608REEL | C20001036M160 |
| R804 | | nsp | NN05273610 | R,CHIP THICK | 27k-J,1/16W-1608REEL | C20002736M160 |
| R805 | | nsp | NN05102610 | R,CHIP THICK | 1k-J,1/16W-1608REEL | C20001026M160 |
| R806 | | nsp | NN05102610 | R,CHIP THICK | 1k-J,1/16W-1608REEL | C20001026M160 |
| R807 | | nsp | NN05102610 | R,CHIP THICK | 1k-J,1/16W-1608REEL | C20001026M160 |
| R808 | | nsp | NN05470610 | R,CHIP THICK | 47-J,1/16W-1608REEL | C20004706M160 |
| R809 | | nsp | NN05103610 | R,CHIP THICK | 10k-J,1/16W-1608REEL | C20001036M160 |
| R810 | | nsp | NN05102610 | R,CHIP THICK | 1k-J,1/16W-1608REEL | C20001026M160 |
| R811 | | nsp | NN05271610 | R,CHIP THICK | 270-J,1/16W-1608REEL | C20002716M160 |
| R813 | | nsp | NN05103610 | R,CHIP THICK | 10k-J,1/16W-1608REEL | C20001036M160 |
| R814 | | nsp | NN05102610 | R,CHIP THICK | 1k-J,1/16W-1608REEL | C20001026M160 |
| R815 | | nsp | NN05271610 | R,CHIP THICK | 270-J,1/16W-1608REEL | C20002716M160 |
| R817 | | nsp | NN05472610 | R,CHIP THICK | 4.7k-J,1/16W-1608REEL | C20004726M160 |
| R818 | | nsp | NN05102610 | R,CHIP THICK | 1k-J,1/16W-1608REEL | C20001026M160 |
| R820 | | nsp | NN05271610 | R,CHIP THICK | 270-J,1/16W-1608REEL | C20002716M160 |
| R821 | | nsp | NN05271610 | R,CHIP THICK | 270-J,1/16W-1608REEL | C20002716M160 |
| R823 | | | | | | |
| ∫ | | nsp | NN05103610 | R,CHIP THICK | 10k-J,1/16W-1608REEL | C20001036M160 |
| R826 | | | | | | |
| R827 | | nsp | NN05182610 | R,CHIP THICK | 1.8k-J,1/16W-1608REEL | C20001826M160 |
| R828 | | nsp | NN05272610 | R,CHIP THICK | 2.7k-J,1/16W-1608REEL | C20002726M160 |
| R829 | | nsp | NN05472610 | R,CHIP THICK | 4.7k-J,1/16W-1608REEL | C20004726M160 |
| R830 | | nsp | NN05822610 | R,CHIP THICK | 8.2k-J,1/16W-1608REEL | C20008226M160 |
| R831 | | nsp | NN05472610 | R,CHIP THICK | 4.7k-J,1/16W-1608REEL | C20004726M160 |
| R832 | | nsp | NN05272610 | R,CHIP THICK | 2.7k-J,1/16W-1608REEL | C20002726M160 |
| R833 | | nsp | NN05182610 | R,CHIP THICK | 1.8k-J,1/16W-1608REEL | C20001826M160 |
| R834 | | nsp | NN05822610 | R,CHIP THICK | 8.2k-J,1/16W-1608REEL | C20008226M160 |
| R835 | | nsp | NN05472610 | R,CHIP THICK | 4.7k-J,1/16W-1608REEL | C20004726M160 |
| R836 | | nsp | NN05272610 | R,CHIP THICK | 2.7k-J,1/16W-1608REEL | C20002726M160 |
| R837 | | nsp | NN05182610 | R,CHIP THICK | 1.8k-J,1/16W-1608REEL | C20001826M160 |
| RM801 | | *HW100520R | *HW100520R | MODULE,REMOCON | NJL64H380A | E940643800000 |
| S801 | | | | | | |
| ∫ | | *SP001140R | *SP001140R | SW,TACT | SKHV10920A,5MM/260G-REEL | G180000270010 |
| S804 | | | | | | |
| S805 | | *SP001220R | *SP001220R | SW,TACT | THHH582GAA /VERTICAL P=4.5 | G180040520020 |
| S806 | | *SP001140R | *SP001140R | SW,TACT | SKHV10920A,5MM/260G-REEL | G180000270010 |
| S807 | | *SP001140R | *SP001140R | SW,TACT | SKHV10920A,5MM/260G-REEL | G180000270010 |
| S808 | | *SP001220R | *SP001220R | SW,TACT | THHH582GAA /VERTICAL P=4.5 | G180040520020 |
| S809 | | | | | | |
| ∫ | | *SP001140R | *SP001140R | SW,TACT | SKHV10920A,5MM/260G-REEL | G180000270010 |
| S812 | | | | | | |
| S813 | | *SP001220R | *SP001220R | SW,TACT | THHH582GAA /VERTICAL P=4.5 | G180040520020 |
| VFD801 | | *HQ300600R | *HQ300600R | DISPLAY,FLT | 16-ST-62GN 89.6*25 DV110/N1S | K530166200010 |
| VR801 | | *SR000170R | *SR000170R | SW,ROTARY | EC12B24S2033ZZZ/WITH PUSH | G120122420330 |
| Z801 | | HD30621000 | HD30621000 | D,ZENER | MTZJ6.2B-0.5W/5MA-52MM | K06006R244520 |
| | | | | S-VIDEO PCB | | |
| C169 | | nsp | nsp | C,CERAMIC HIK AXIAL | 0.1µF-Z/50V-52RE | D005104597530 |
| C170 | | nsp | nsp | C,CERAMIC HIK AXIAL | 0.1µF-Z/50V-52RE | D005104597530 |
| C208 | | nsp | DK96104300 | C,CERAMIC CHIP HIK | 0.1µF-K/50V-1608REEL | D011104577160 |
| CP205 | | nsp | nsp | CN.WAFER 2.0MM | 53015-0910 9P ANGLE | L101530150910 |

NOTE : *nsp* PART IS LISTED FOR REFERENCE ONLY, MARANTZ WILL NOT SUPPLY THESE PARTS.

| POS. NO | VERS. COLOR | PART NO. (FOR EUR) | PART NO. (MJI) | DESCRIPTION | | |
|---------|-------------|--------------------|----------------|-------------------------------|-------------------------------|---------------|
| CP206 | | nsp | nsp | CN.WAFER 2.0MM | 53015-0310 3P ANGLE | L101530150310 |
| J202 | | | | | | |
| } | | nsp | nsp | CN,WIRE 1P | JUMPER (0.6/52MM) | L045084006040 |
| J207 | | | | | | |
| JACK204 | | *YT003090R | *YT003090R | TERMINAL CINCH 6PIN | JB060015EN | G603060015000 |
| JACK205 | | *YT003070R | *YT003070R | TERMINAL CINCH 1PIN | Y/CJACK, 205902004/YKF51-5508 | G600000010020 |
| L201 | | | | | | |
| } | | *FC900290R | *FC900290R | BEAD,COIL CHIP | HB-IT2012-121JT 2012REEL | 7611010000020 |
| L206 | | | | | | |
| L213 | | *FC900290R | *FC900290R | BEAD,COIL CHIP | HB-IT2012-121JT 2012REEL | 7611010000020 |
| R140 | | nsp | nsp | R,FIXED,CARBON FILM | RD-T-1/6WJ-47 1.9*3.2 52REEL | N111112647010 |
| R207 | | nsp | NN05000610 | R,CHIP THICK | 0-J,1/16W-1608REEL | C20000006M160 |
| SW201 | | *SS000700R | *SS000700R | SW,SLIDE | SSAF112NA011 | G060112011010 |
| | | | | | | |
| | | | | SCART PCB | | |
| C204 | | nsp | DK96104300 | C,CERAMIC CHIP HIK | 0.1µF-K/50V-1608REEL | D011104577160 |
| C205 | | nsp | DK96102300 | C,CERAMIC CHIP HIK | 1000pF-K/50V-1608REEL | D011102777160 |
| C206 | | nsp | DK96104300 | C,CERAMIC CHIP HIK | 0.1µF-K/50V-1608REEL | D011104577160 |
| C207 | | nsp | DK96102300 | C,CERAMIC CHIP HIK | 1000pF-K/50V-1608REEL | D011102777160 |
| CP203 | | nsp | nsp | CN.WAFER 2.0MM | 53015-0710 7P ANGLE | L101530150710 |
| CP204 | | nsp | nsp | CN.WAFER 2.0MM | 53015-0310 3P ANGLE | L101530150310 |
| J208 | | | | | | |
| } | | nsp | nsp | CN,WIRE 1P | JUMPER (0.6/52MM) | L045084006040 |
| J212 | | | | | | |
| JACK203 | | *YT003060R | *YT003060R | JACK,MODULAR | DV110,SCART CS21C1110P | G40621C111000 |
| JACK206 | | *YT003080R | *YT003080R | TERMINAL CINCH 2PIN | JE020059FN(GND) (BK,BK) | G601020170050 |
| L207 | | | | | | |
| } | | *FC900290R | *FC900290R | BEAD,COIL CHIP | HB-IT2012-121JT 2012REEL | 7611010000020 |
| L214 | | | | | | |
| R205 | | nsp | NN05750610 | R,CHIP THICK | 75-J,1/16W-1608REEL | C20007506M160 |
| R206 | | nsp | NN05750610 | R,CHIP THICK | 75-J,1/16W-1608REEL | C20007506M160 |
| R208 | | nsp | NN05391610 | R,CHIP THICK | 390-J,1/16W-1608REEL | C20003916M160 |
| R209 | | nsp | *NN000490R | R,CHIP THICK | 91-J,1/16W-1608REEL | C20009106M160 |
| TP201 | | *LC107290R | *LC107290R | COIL,CHOKE | COIL TRANS MATCHING | D300010250000 |
| | | | | | | |
| | | | | POWER SUPPLY(SMPS) PCB | | |
| ▲ F1 | | *FS001020R | *FS001020R | FUSE | T2AL/250V | G659202251010 |

NOTE : "nsp" PART IS LISTED FOR REFERENCE ONLY, MARANTZ WILL NOT SUPPLY THESE PARTS.